

**MEADE**<sup>®</sup>  
www.meade.com



**MEADE INSTRUCTION MANUAL**

**114mm | 4.5" Equatorial Reflecting Telescope**



**114EQ-AR**



## **WARNING!**

**Never use a Meade® Telescope to look at the Sun!** Looking at or near the Sun will cause instant and irreversible damage to your eye. Eye damage is often painless, so there is no warning to the observer that damage has occurred until it is too late. Do not point the telescope at or near the Sun. Do not look through the telescope as it is moving. Children should always have adult supervision while observing.

## INTRODUCTION

Your telescope is an excellent beginner's instrument, and is designed to observe objects in the night sky. It can be your personal window on the universe.

The telescope is shipped with the following parts:

- Optical tube
- Steel tube tripod with an accessory tray
- Two 1.25" eyepieces: MA25mm (36X), MH9mm (100X)
- Red dot viewfinder with bracket
- Telescope mount
- Hardware used in the assembly:

The tube has a focal length of 900mm, and its reflective mirror has a diameter of 114mm. The lens diameter is one of the most important pieces of information about the telescope. The size of the primary mirror determines how much detail you will be able to see in your telescope. The focal length information will help later on to calculate magnification.

Setting up your telescope involves these simple steps:

- Assemble your tripod
- Attach the accessory tray
- Attach the red dot viewfinder
- Attach the eyepiece
- Attach the counterweight
- Prepare mount
- Attach the optical tube to the mount

Study the the picture on the next page and become acquainted with the parts of your telescope. Then proceed to "Assemble your Tripod."

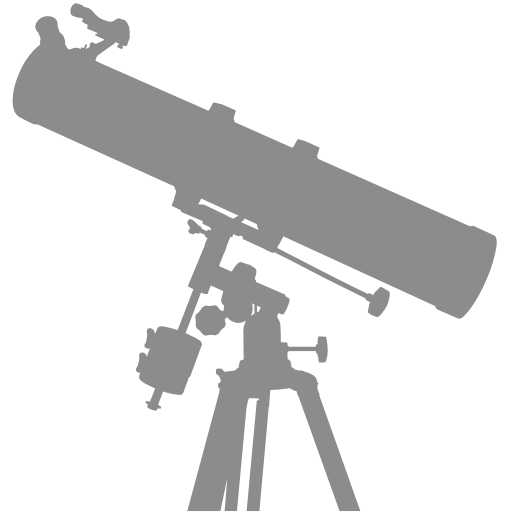

# FIGURE 1

**Figure 1:** Meade 114EQ-AR Equatorial Reflecting Telescope

**Inset A:**

Accessory Tray

**Inset B:**

Red Dot Viewfinder Assembly

**Inset C:**

Tripod Leg

1. Tripod legs
2. Equatorial Mount
3. Right ascension control cable
4. Declination control cable
5. Counterweight
6. Counterweight shaft
7. Counterweight lock knob
8. Counterweight safety washer
9. Latitude adjustment lock
10. Polar axis (see Fig. 4)
11. Latitude adjustment knob
12. Main optical tube (OTA)
13. Optical tube saddle plate (see Fig. 4)
14. Cradle ring
15. Cradle ring lock knob
16. Red dot viewfinder bracket mounting thumbscrews (see Inset B)
17. Focuser
18. Focuser lock thumbscrew
19. Eyepiece
20. Red dot viewfinder bracket (see Inset B)
21. Declination axis (see Fig. 4)
22. Right Ascension lock (see Fig. 4)
23. Declination lock
24. Red dot viewfinder
25. Telescope front dust cover
26. Eyepiece holder slots (see Inset A)
27. Right Ascension setting circle
28. Declination setting circle (see Fig. 4)
29. Latitude dial
30. Azimuth adjustment lock (see Fig. 4)
31. Focus knobs
33. Azimuth base (see Fig. 4)
34. Red dot viewfinder alignment screws (see Inset B)
35. Azimuth circle (see Fig. 4)
36. Cradle ring attachment knobs (2-places)
37. Tripod leg Phillips-head bolt (see Fig. 5)
38. Tripod-legs-to-mount nut (3-places)
39. Accessory tray (see Inset A)
40. Leg brace support (see Inset A)
41. Sliding leg extension lock (see Inset C)
42. Sliding leg extension (see Inset C)

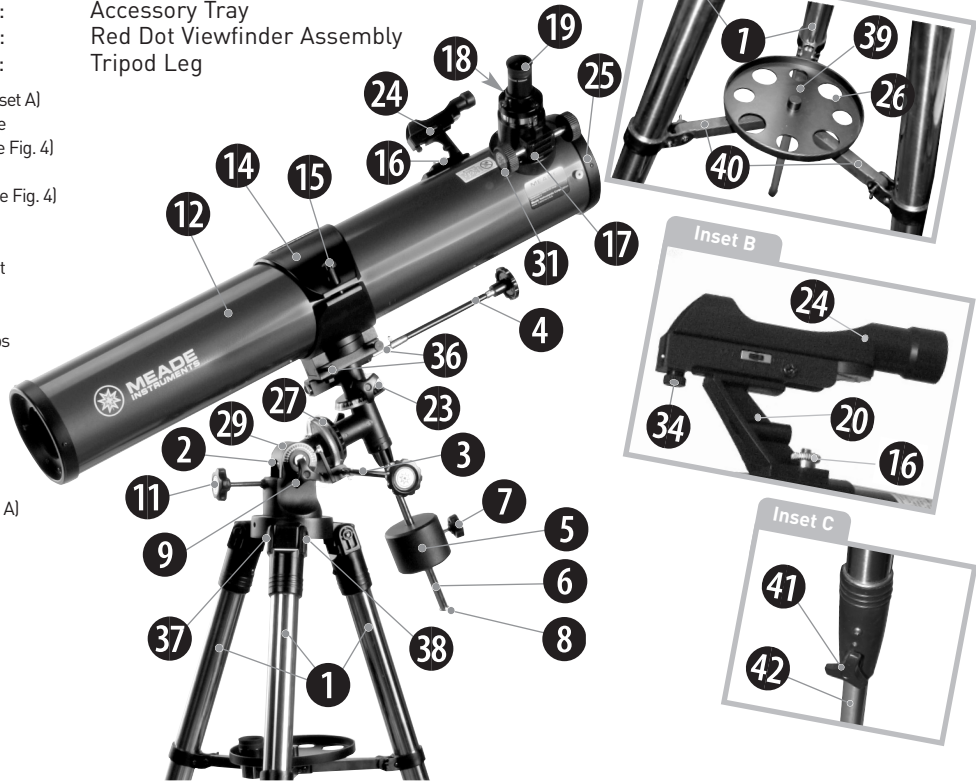

## ASSEMBLE YOUR TRIPOD

The tripod is the basic support for your telescope. Its height may be adjusted so that you can view comfortably. **Note: Number in brackets, e.g., (3), refer to Fig. 1 unless noted otherwise.**

1. Make sure that as you attach the legs (1) to the mount that the leg braces (40) are facing inward.

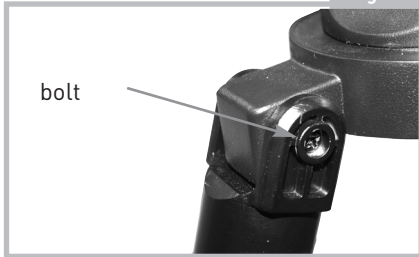

2. Locate the three (3) 2-inch bolts and matching nuts.
3. At the top of the legs are holes for which the 2-inch bolt and matching nut will pass-through.
4. Note that one side has a molded-in hex shaped receiver that will capture and lock the nut for the 2-inch bolt. Make sure that

you insert the nut in this side and slide the 2-inch bolt through the other. Keep finger on the nut as you tighten the bolt using a Philips/cross headed screw driver. Secure to finger tight.

5. Attach the remaining two legs to the mount in the same manner.
6. Spread the legs out evenly apart.
7. Set the height of your tripod:
  - a. Rotate and loosen the leg lock (41) to unlock the leg lock.
  - b. Slide the inner portion of the leg in or out to the desired length. Repeat for the other two legs.
  - c. Rotate and tighten the leg lock to relock the leg lock.
  - d. Repeat for the other two legs.

## ATTACH THE LEG BRACE SUPPORT

The leg brace support stabilizes the tripod and is the base for the accessory tray.

1. Locate leg brace support (40, See Fig. 1, Inset A) along with the three 1" long bolts and matching wing nuts. Unfold the collapsed leg brace supports.
2. Attach the lag brace support to each of the three mounting points on the legs

using the above 1" long bolts and wing nut. The wing nuts need only to be "finger-tight". Repeat for the remaining two fastening points.

5. Repeat with the other two leg braces.

## ATTACH THE ACCESSORY TRAY.

The circular accessory tray is a convenient holder for eyepieces and Meade accessories such as the Barlow lens.

1. Locate the circular Accessory Tray (39), See Fig. 1, Inset A).
2. Position the accessory trays captive threaded mounting bolt at the center of the leg brace support and spin-on to secure the accessory tray. Finger tight only (do not over tighten).

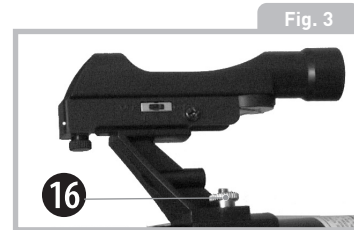

Looking at or near the **Sun** will cause **irreversible** damage to your eye. Do not point this telescope at or near the Sun. Do not look through the telescope as it is moving.

## ATTACH THE RED DOT VIEWFINDER

An eyepiece (19) has a narrow field of view. A viewfinder (24) has a wider field of view, which makes it easier to locate objects. The red dot viewfinder has a red dot to make it easier to line up a target more precisely.

1. Note the two thumbscrews (16, Fig1. Inset B) thread onto two bolts on the optical tube. Remove the thumbscrews from the tube.
2. Line up the two holes on the red dot viewfinder bracket over the two bolts. Slide the bracket over the bolts as shown in Fig 1.
3. Replace the thumbscrews onto the bolts and tighten to a firm feel.

## INSERT THE EYEPIECE

1. Slide the MA25mm eyepiece (19) into eyepiece holder on the focuser (17).
2. Tighten the focuser thumbscrew to hold the eyepiece securely.

## ATTACH THE COUNTERWEIGHT

1. Threading the shaft into the base of the declination axis (Fig. 4). Be sure to support the counterweight with one hand while performing this step.
2. Hold the counterweight (5) firmly in one hand, slide it onto the counterweight shaft (6).
3. Slide the counterweight to a position about 2 inches from the bottom of the shaft.
4. Secure in place by tightening the counterweight lock (7).

**Note:** Make sure the safety washer and screw (8) always remain in place on the shaft. **This safety feature prevents the counterweight from accidentally slipping off the shaft.**

## BALANCING THE TELESCOPE

In order for the telescope to move smoothly on its mechanical axes, it must first be balanced as follows:

**Note:** If the counterweight is positioned as recommended previously then the telescope is already approximately balanced.

Fig. 4

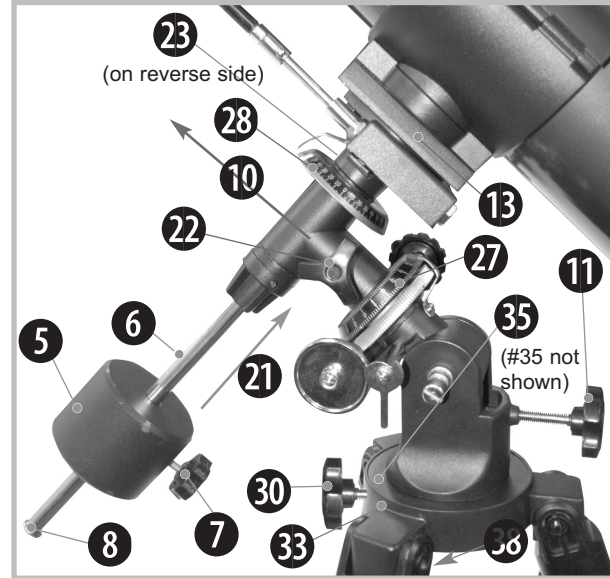

(see p. 2 for feature names)



Looking at or near the **Sun** will cause **irreversible** damage to your eye. Do not point this telescope at or near the Sun. Do not look through the telescope as it is moving.

1. Loosen the right ascension lock (22). The telescope mount will turn freely about the polar axis. Rotate the telescope about the polar axis so that the counterweight shaft (6) is parallel to the ground (horizontal).
2. Loosen the counterweight's locking thumbscrew (7) and slide the counterweight (5) along the shaft until the telescope remains in any given position without tending to drift up or down around the polar axis. Retighten the counterweight lock (7). The telescope is now balanced.

## PREPARE MOUNT

1. Attach the flexible cables (3) and (4). These cables are secured in place with a firm tightening of the thumbscrews located at the attachment ends of each cable.
2. Loosen the latitude adjustment lock (9) so you can move the mount to the desired position: tilt the polar axis of the telescope to roughly a 45° angle with the horizon.



### SUN WARNING! NEVER USE YOUR TELESCOPE TO LOOK AT THE SUN!

LOOKING AT OR NEAR THE SUN WILL CAUSE INSTANT AND IRREVERSIBLE DAMAGE TO YOUR EYE. EYE DAMAGE IS OFTEN PAINLESS, SO THERE IS NO WARNING TO THE OBSERVER THAT DAMAGE HAS OCCURRED UNTIL IT IS TOO LATE. DO NOT POINT THE TELESCOPE OR ITS VIEWFINDER AT OR NEAR THE SUN. DO NOT LOOK THROUGH THE TELESCOPE OR ITS VIEWFINDER AS IT IS MOVING. CHILDREN SHOULD ALWAYS HAVE ADULT SUPERVISION WHILE OBSERVING.

3. Re-tighten the latitude adjustment lock to secure the mount in place.

## ATTACH THE OPTICAL TUBE TO THE MOUNT

1. Lay the optical tube (12) with cradle rings (14) onto the saddle plate (13, Fig. 4).
2. Tighten the Saddle plate attachment lock knob (36) to a firm feel.

## ALIGN THE RED DOT VIEWFINDER

Fig. 5

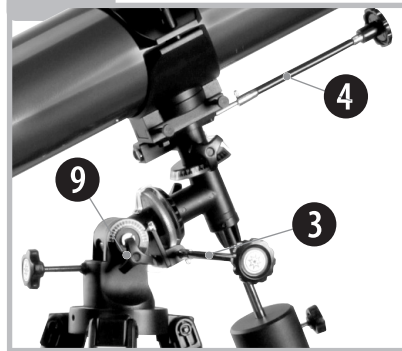

Perform the first part of this procedure during the daytime and the last step at night.

1. Point the telescope at an easy-to-find land object such as the top of a telephone pole or a distant mountain or tower. Look through the eyepiece and turn the focuser knob (31) until the image is sharply focused. Center the object precisely in the eyepiece's field of view.  
**Note:** You have a **reflecting telescope**, objects will appear upside down and reversed left-for-right. This will not make a difference when observing astronomical



Looking at or near the **Sun** will cause **irreversible** damage to your eye. Do not point this telescope at or near the Sun. Do not look through the telescope as it is moving.

objects, and in fact, all astronomical telescopes present inverted images. No means of correcting the image is available for **reflecting telescopes**—the image will always appear upside down and reversed left-for-right.

2. Look through the red dot viewfinder. Turn one or more of the viewfinder's alignment screws (34, Inset B) until the red dot is precisely over the same object as you centered in the eyepiece.
3. Check this alignment at night on a celestial object, such as the Moon or a bright star, and use the viewfinder's alignment screws to make any necessary refinements.

## UNDERSTANDING CELESTIAL MOVEMENTS AND COORDINATES

Understanding where to locate celestial objects and how those objects move across the sky is the key to enjoying the hobby of astronomy. Most amateur astronomers practice "star-hopping" to locate celestial objects. They use star charts or astronomical software to identify bright

stars and star patterns as "landmarks" in their search for astronomical objects. Another technique for locating objects is to use the setting circles that are provided on your telescope.

## UNDERSTANDING HOW CELESTIAL OBJECTS MOVE

Due to the Earth's rotation, celestial bodies appear to move from East to West in a curved path through the skies.

All stars and celestial objects are mapped onto an imaginary sphere surrounding the Earth. This mapping system is similar to the system of latitude and longitude on Earth surface maps.

In mapping the surface of the Earth, lines of longitude are drawn between the North and South Poles and lines of latitude are drawn in an East-West direction, parallel to the Earth's equator. Similarly, imaginary lines have been drawn to form a latitude and longitude on the celestial sphere. These lines are known as **Right Ascension** and **Declination**.

The celestial map also contains two poles and an equator just like a map of the Earth. The celestial poles are defined as those two points where the Earth's North and South poles, if extended to infinity, would cross the celestial sphere. Thus, the North Celestial Pole is that point in the sky where the North Pole crosses the celestial sphere. The North Star, Polaris, is located very near the North Celestial Pole.

So just as an object's position on the Earth's surface can be located by its latitude and longitude, celestial objects may also be

## Meade Factoid

Just below the constellation Orion's famous belt of three stars (in the middle of his sword), is The Great Orion Nebula. This wonderful telescope target is really a cosmic star factory where a glowing gas cloud surrounds hot young stars.



Looking at or near the **Sun** will cause **irreversible** damage to your eye. Do not point this telescope at or near the Sun. Do not look through the telescope as it is moving.



located using Right Ascension and Declination. For example: You can locate Los Angeles, California, by its latitude (+34°) and longitude (118°). Similarly, you can locate the Ring Nebula (also known as "M57") by its Right Ascension (18hr) and its Declination (+33°).

- **RIGHT ASCENSION (R.A.):** This Celestial version of longitude is measured in units

Fig. 7

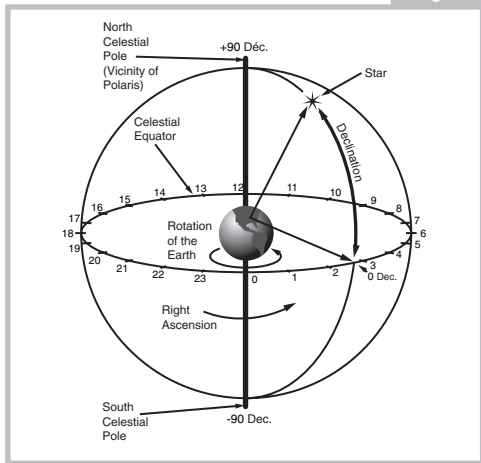

of hours (hr), minutes (min), and seconds (sec) on a 24 hour "clock" (similar to how Earth's time zones are determined by longitude lines). The "zero" line was chosen to pass through the constellation Pegasus, a sort of cosmic Greenwich meridian. R.A. coordinates range from 0hr 0min 0sec to 23hr 59min 59sec. There are 24 primary lines of R.A., located at 15-degree intervals along the celestial equator. Objects located further and further East of the zero R.A. grid line (0hr 0min 0sec) carry higher R.A. coordinates.

- **Declination (Dec.):** This celestial version of latitude is measured in degrees, arc-minutes, and arc-seconds (e.g., 15° 27' 33"). Dec. locations North of the celestial equator are indicated with a plus (+) sign (e.g., the Dec. of the North celestial pole is +90°). Any point on the celestial equator (such as the constellations of Orion, Virgo, and Aquarius) is said to have a Declination of zero, shown as 0° 0' 0".

All celestial objects therefore may be located with their celestial coordinates of Right Ascension and Declination.

## LINING UP WITH THE CELESTIAL POLE

Objects in the sky appear to revolve around the celestial pole. (Actually, celestial objects are essentially "fixed" and their apparent motion is caused by Earth's rotation). During any 24 hour period, stars make one complete revolution about the pole, circling with the pole at the center. By lining up the telescope's polar axis with the North Celestial Pole (or for observers located in Earth's Southern Hemisphere with the South Celestial Pole), astronomical objects may be followed, or "tracked," by moving the telescope about one axis, the polar axis.

If the telescope is reasonably well aligned with the pole very little use of the telescope's Declination flexible cable control is necessary. Virtually all of the required telescope tracking will be in Right Ascension. For the purposes of casual visual telescopic observations, lining up the telescope's polar axis to within a degree or two of the pole is more than sufficient: with this level of pointing accuracy, the telescope can track accurately by the user slowly



Looking at or near the **Sun** will cause **irreversible** damage to your eye. Do not point this telescope at or near the Sun. Do not look through the telescope as it is moving.

turning the telescope's R.A. flexible cable control and keep objects in the telescopic field of view for perhaps 20 to 30 minutes.

## POLAR ALIGNMENT OF THE EQUATORIAL MOUNT

To line up the Meade 114 EQ-AR with the pole, follow this procedure:

1. Release the Azimuth lock (30) of the Azimuth base, so that the entire telescope-with-mounting may be rotated in a horizontal direction. Rotate the telescope until it points due North. Use a compass or locate Polaris, the North Star, as an accurate reference to North (See Fig. 7). Now retighten the Azimuth lock.
2. Level the mount with the horizon, if necessary, by adjusting the heights of the three tripod legs.
3. Determine the latitude of your observing location by checking a road map or atlas. Release the latitude lock (9) and tilt the telescope mount so that the star "Polaris" is centered in the telescope's viewfinder, then re-tighten the latitude

lock.

4. If the above steps (1-3) were performed with reasonable accuracy, your telescope is now sufficiently well-aligned to the North Celestial Pole for visual observations.

Once the mount has been polar-aligned as described above, the latitude angle need not be adjusted again, unless you move to a different geographical location (i.e. a different latitude). The only polar alignment procedure that you need to perform each time you use the telescope is to point the polar axis due North, as

### TOO MUCH POWER?

Can you ever have too much power? If the type of power you're referring to is eyepiece magnification, yes you can! The most common mistake of the beginning observer is to "overpower" a telescope by using high magnifications which the telescope's aperture and atmospheric conditions cannot reasonably support. Keep in mind that a smaller, but bright and well-resolved image is far superior to one that is larger, but dim and poorly resolved. Powers above 400x should be employed only under the steadiest atmospheric conditions.

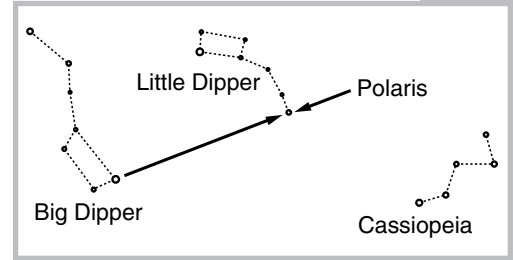

described in step 1 above.

## THE MOST IMPORTANT RULE

We have one very important rule that you should always follow when using your telescope:

# Have Fun!

Have a good time when you're observing. You may not know everything that there is to know about a telescope or what all the sights in the universe are, but that's OK. Just point and observe at first.

You will enjoy your telescope even more as you learn more about it. But don't be scared



Looking at or near the **Sun** will cause **irreversible** damage to your eye. Do not point this telescope at or near the Sun. Do not look through the telescope as it is moving.

off by difficult terms or complicated procedures. Don't panic! Just relax and enjoy your scope.

You will begin to grow and learn more about astronomy the more you observe. Go to the library and read some books about the stars and planets. Read about astronomers of old. Many of them had telescope no bigger than the one you are using right now. Galileo, who is one of the first astronomers to use a telescope, discovered four of the moons of Jupiter with a telescope about the same size as yours (and his didn't even focus very well!).

## OBSERVING

**Observe during the daytime:** Try out your telescope during the daytime at first. It is easier to learn how it operates and how to observe when it is light.

**Pick out an easy object to observe:** A distant mountain, a large tree, a lighthouse or skyscraper make excellent targets. Point the optical tube so it lines up with your object. **Objects will appear upside down and backwards in this model telescope.**

**Unlock the lock knobs:** To move the

telescope, you will need to unlock the Right Ascension (22, Fig. 4) and Declination (23, Fig. 4) lock knobs (just rotate to unlock or lock; when locking, only tighten to a "firm feel," do not overtighten).

**Use the red dot viewfinder:** If you have not done so, align the viewfinder (24) with the telescope's eyepiece (19) as described earlier. Look through the red dot viewfinder until you can see the object. It will be easier to locate an object using the red dot viewfinder rather than locating with the eyepiece. Line up the object using the viewfinders red dot.

**Look through the eyepiece:** Once you have the object lined up in the viewfinder, look through the optical tube's eyepiece. If you have aligned your viewfinder, you will see the object in your eyepiece. Always begin viewing an object using the 25mm eyepiece, since it provides a wider field of view.

**Focus:** Look through the eyepiece and practice focusing on the object you have chosen.

**Try out the slow-motion flexible cable control:** Practice using the right ascension control cable (3) and declination control

cable (4) to move the telescope. These can come in very handy, especially when you wish to move the telescope in very small (fine control) steps.

**Observe the Moon:** When you feel comfortable with the viewfinder, the eyepieces, the locks and the adjustment controls, you will be ready to try out the telescope at night. The Moon is the best object to observe the first time you go out at night. Pick a night when the Moon is a crescent. No shadows are seen during a full Moon, making it appear flat and uninteresting.

Look for different features on the Moon. The

## Meade Factoid

Jupiter's four brightest moons are easily visible in a telescope. When Galileo Galilei first observed them rotating around Jupiter in 1610, he saw proof that the earth wasn't the center of everything in the universe, as many then supposed.

most obvious features are craters. In fact you can see craters within craters. Some craters have bright lines about them. These are called rays and are the result of material thrown out of the crater when it was struck by a colliding object. The dark areas on the Moon are called maria and are composed of lava from the period when the Moon still had volcanic activity. You can also see mountain ranges and fault lines on the Moon.

Use a neutral density filter (often called a “moon filter”) when observing the Moon. Neutral density filters are available from Meade as an optional accessory and

## Meade Factoid

Saturn's rings of ice, dust and gas are huge and small at the same time. The main rings are so large they could almost reach from the earth to the moon. But they are only about a half of a mile (just a few city blocks) wide.

enhance contrast to improve your observation of lunar features.

Spend several nights observing the Moon. Some nights, the Moon is so bright that it makes other objects in the sky difficult to see. These are nights that are excellent for lunar observation.

**Observe the Solar System:** After observing the Moon, you are ready to step up to the next level of observation, the planets. There are four planets that you can easily observe in your telescope: Venus, Mars, Jupiter and Saturn.

Nine planets (maybe more!) travel in a fairly circular pattern around our Sun. Any system of planets orbiting one or more stars is called a solar system. Our Sun, by the way, is a single, yellow dwarf star. It is average as far as stars go and is a middle aged star.

Beyond the planets are clouds of comets, icy planetoids and other debris left over from the birth of our sun. Recently astronomers have found large objects in this area and they may increase the number of planets in our solar system.

Fig. 9



The four planets closest to the Sun are rocky and are called the inner planets. Mercury, Venus, Earth and Mars comprise the inner planets. Venus and Mars can be easily seen in your telescope.

Venus is seen before dawn or after sunset, because it is close to the Sun. You can observe Venus going through crescent phases. But you cannot see any surface detail on Venus because it has a very thick atmosphere of gas.

When Mars is close to the Earth, you can see some details on Mars, and sometimes even Mars' polar caps. But quite often, Mars is further away and just appears as a red dot



Looking at or near the **Sun** will cause **irreversible** damage to your eye. Do not point this telescope at or near the Sun. Do not look through the telescope as it is moving.

with some dark lines crisscrossing it.

Jupiter, Saturn, Uranus, Neptune and Pluto comprise the outer planets. These planets, except for Pluto, are made mostly of gases and are sometimes called gas giants. If they had grown much bigger, they may have become stars. Pluto is made mostly of ice.

Jupiter is quite interesting to observe. You can see bands across the face of Jupiter. The more time you spend observing these bands, the more details you will be able to see.

One of the most fascinating sights of Jupiter are its moons. The four largest moons are called the Galilean moons, after the astronomer Galileo, who observed them for the first time. If you've never watched the Galilean moons in your telescope before, you're missing a real treat! Each night, the moons appear in different positions around the Jovian sky. This is sometimes called the Galilean dance. On any given night, you might be able to see the shadow of a moon on the face of Jupiter, see one moon eclipse another or even see a moon emerge from behind Jupiter's giant disk. Drawing the positions of the moons each night is an

excellent exercise for novice astronomers.

Any small telescope can see the four Galilean moons of Jupiter (Fig. 9), plus a few others, but how many moons does Jupiter actually have? No one knows for sure! Nor are we sure how many Saturn has either. At last count, Jupiter had over 60 moons, and held a small lead over Saturn. Most of these moons are very small and can only be seen with very large telescopes.

Probably the most memorable sight you will see in your telescope is Saturn. Although you may not see many features on the surface of Saturn, its ring structure will steal your breath away. You will probably be able to see a black opening in the rings, known as the Cassini band.

Saturn is not the only planet that has rings, but it is the only set of rings that can be seen with a small telescope. Jupiter's rings cannot be seen from Earth at all—the Voyager spacecraft discovered the ring after it passed Jupiter and looked back at it. It turns out, only with the sunlight shining through them, can the rings be seen. Uranus and Neptune also have faint rings.

Optional color filters help bring out detail and contrast of the planets. Meade offers a line of inexpensive color filters.

### What's Next? Beyond the Solar System:

Once you have observed our own system of planets, it's time to really travel far from home and look at stars and other objects.

You can observe thousands of stars with your telescope. At first, you may think stars are just pinpoints of light and aren't very interesting. But look again. There is much information that is revealed in stars.

#### SURF THE WEB

- The Meade 4M Community:  
<http://www.meade4m.com>
- *Sky & Telescope*:  
<http://www.skyandtelescope.com>
- *Astronomy*:  
<http://www.astronomy.com>
- Astronomy Picture of the Day:  
<http://antwrp.gsfc.nasa.gov/apod>
- Photographic Atlas of the Moon:  
[http://www.lpi.ursa.edu/research/lunar\\_orbiter](http://www.lpi.ursa.edu/research/lunar_orbiter)
- Hubble Space Telescope Public Pictures:  
<http://oposite.stsci.edu/pubinfo/pictures.html>



Looking at or near the **Sun** will cause **irreversible** damage to your eye. Do not point this telescope at or near the Sun. Do not look through the telescope as it is moving.

The first thing you will notice is that not all stars are the same colors. See if you can find blue, orange, yellow, white and red stars. The color of stars sometimes can tell you about the age of a star and the temperature that they burn at.

Other stars to look for are multiple stars. Very often, you can find double (or binary) stars, stars that are very close together. These stars orbit each other. What do you notice about these stars? Are they different colors? Does one seem brighter than the other?

Almost all the stars you can see in the sky are part of our galaxy. A galaxy is a large grouping of stars, containing millions or even billions of stars. Some galaxies form a spiral (like our galaxy, the Milky Way) and other galaxies look more like a large football and are called elliptical galaxies. There are many galaxies that are irregularly shaped and are thought to have been pulled apart because they passed too close to—or even through—a larger galaxy.

You may be able to see the Andromeda galaxy and several others in your telescope.

They will appear as small, fuzzy clouds. Only very large telescope will reveal spiral or elliptical details.

You will also be able to see some nebulas with your scope. Nebula means cloud. Most nebulas are clouds of gas. The two easiest to see in the Northern Hemisphere are the Orion nebula during the winter and the Triffid nebula during the summer. These are large clouds of gas in which new stars are being born. Some nebulas are the remains of stars exploding. These explosions are called supernovas.

When you become an advanced observer you can look for other types of objects such as asteroids, planetary nebula and globular clusters. And if you're lucky, every so often a bright comet appears in the sky, presenting an unforgettable sight.

The more you learn about objects in the sky, the more you will learn to appreciate the sights you see in your telescope. Start a notebook and write down the observations you make each night. Note the time and the date.

Use a compass to make a circle, or trace

around the lid of a jar. Draw what you see in your eyepiece inside the circle. The best exercise for drawing is to observe the moons of Jupiter every night or so. Try to make Jupiter and the moons approximately the same size as they look in your eyepiece. You will see that the moons are in a different position every night. As you get better at drawing, try more challenging sights, like a crater system on the moon or even a nebula.

Go your library or check out the internet for more information about astronomy. Learn about the basics: light years, orbits, star colors, how stars and planets are formed, red shift, the big bang, what are the different

Fig. 10



Looking at or near the **Sun** will cause **irreversible** damage to your eye. Do not point this telescope at or near the Sun. Do not look through the telescope as it is moving.

kinds of nebula, what are comets, asteroids and meteors and what is a black hole. The more you learn about astronomy, the more fun, and the more rewarding your telescope will become.

## SOME OBSERVING TIPS

**Eyepieces:** Always begin your observations using the 25mm low-power eyepiece. The 25mm eyepiece delivers a bright, wide field of view and is the best to use for most viewing conditions. Use the high-power 9mm eyepiece to view details when observing the Moon and planets. If the image become fuzzy, switch back down to a lower power. Changing eyepieces changes the power or magnification of your telescope.

By the way, you might have noticed something strange when you looked through your eyepiece. The image is upside down and reversed. That means reading words can be a problem. But it has no affect on astronomical objects.

**Optional Accessory Barlow lens:** You can also change magnification by using a Barlow lens. The Barlow lens doubles the power of your telescope (See Fig. 10).

Meade offers a complete line of eyepieces for your telescope. Most astronomers have four or five low-power and high power eyepieces to view different objects and to cope with different viewing conditions.

**Objects move in the eyepiece:** If you are observing an astronomical object (the Moon, a planet, star, etc.) you will notice that the object will begin to move slowly through the telescopic field of view. This movement is caused by the rotation of the Earth and makes an object move through the telescope's field of view. To keep astronomical objects centered in the field, simply move the telescope on one or both of its axes—vertically and/or horizontally as needed—try using the telescopes coarse and fine adjustment controls. At higher powers, astronomical objects will seem to move through the field of view of the eyepiece more rapidly.

Place the object to be viewed at the edge of the field and, without touching the telescope, watch it drift through the field to the other side before repositioning the telescope so that the object to be viewed is

again placed at the edge of the field, ready to be further observed.

**Vibrations:** Avoid touching the eyepiece while observing through the telescope. Vibrations resulting from such contact will cause the image to move. Avoid observing sites where vibrations cause image movement (for example, near railroad tracks). Viewing from the upper floors of a building may also cause image movement.

**Let your eyes “dark-adapt:”** Allow five or ten minutes for your eyes to become “dark adapted” before observing. Use a red-filtered flashlight to protect your night vision

### STAR CHARTS

Star charts and planispheres are useful for a variety of reasons. In particular, they are a great aid in planning a night of celestial viewing.

A wide variety of star charts are available in books, in magazines, on the internet and on CD Roms. Meade offers AutoStar Suite™ software. Contact your local Meade dealer or Meade's Customer Service department for more information.

*Astronomy and Sky and Telescope* magazines print star charts each month for up-to-the-minute maps of the heavens.



Looking at or near the **Sun** will cause **irreversible** damage to your eye. Do not point this telescope at or near the Sun. Do not look through the telescope as it is moving.

when reading star maps, or inspecting the telescope. Do not use a regular flash-light or turn on other lights when observing with a group of other astronomers. You can make your own red filtered flashlight by taping red cellophane over a flashlight lens.

**Viewing through windows:** Avoid setting up the telescope inside a room and observing through an opened or closed window pane. Images may appear blurred or distorted due to temperature differences between inside and outside air. Also, it is a good idea to allow your telescope to reach the ambient (surrounding) outside temperature before

## Meade Factoid

The Sun is gigantic. It would take 109 earths side-by-side to make up the diameter of the sun, and 1.3 million Earth's to fill its volume.

Yet, due to distance, the Sun looks exactly the same size as the moon in our sky.

starting an observing session.

**When to observe:** Planets and other objects viewed low on the horizon often lack sharp-ness—the same object, when observed higher in the sky, will appear sharper and have greater contrast. Try reducing power (change your eyepiece) if your image is fuzzy or shimmers. Keep in mind that a bright, clear, but smaller image is more interesting than a larger, dimmer, fuzzy one. Using too high a power eyepiece is one of the most common mistakes made by new astronomers.

**Dress Warm:** Even on summer nights, the air can feel cool or cold as the night wears on. It is important to dress warm or to have a sweater, jacket, gloves, etc., nearby.

**Know your observing site:** If possible, know the location where you will be observing. Pay attention to holes in the ground and other obstacles. Is it a location where wild animals, such as skunks, snakes, etc., may appear? Are there viewing obstructions such as tall trees, street lights, headlights and so forth? The best locations are dark locations, the darker the better. Deep space objects

are easiest to see under dark skies. But it is still possible to observe even in a city.

**Surf the Web and visit your local library:** The internet contains a huge amount of astronomical information, both for children and adults. Check out astronomy books from your library. Look for star charts—these are available on a monthly basis in *Astronomy* and *Sky and Telescope* magazines.

## HAVE A GOOD TIME, ASTRONOMY IS FUN!

### JOIN AN ASTRONOMY CLUB, ATTEND A STAR PARTY

One of the best ways to increase your knowledge of astronomy is to join an astronomy club. Check your local newspaper, school, library, or telescope dealer/store to find out if there's a club in your area.

Many groups also hold regularly scheduled Star Parties at which you can check out and observe with many different telescopes and other pieces of astronomical equipment. Magazines such as *Sky and Telescope* and *Astronomy* print schedules for many popular Star Parties around the United States and Canada.



Looking at or near the **Sun** will cause **irreversible** damage to your eye. Do not point this telescope at or near the Sun. Do not look through the telescope as it is moving.



## SPECIFICATIONS

- Optical tube focal length . . 900mm
- Primary mirror diameter . 114mm (4.5 inch)
- Focal ratio. . . . . f/8
- Mounting type. . . . . Equatorial

### What do the specifications mean?

Optical tube focal length is simply a measurement of the length of the optical tube. In other words, this is the distance light travels in the telescope before being brought to focus in you eyepiece. Your tube is

900mm long.

Primary diameter is how big the mirror is on your scope. Telescopes are always described by how large their primary mirror is. Your telescope is 114mm or 4.5 inches. Other telescopes are 90mm, 8 inches, 16 inches, or even 3 feet in diameter. The Hubble Telescope’s objective mirror has a diameter of 2.4 meters (that’s 7.8 feet across!).

The focal ratio helps determine how fast the photographic speed of a telescope is. The lower the focal ratio number, the faster the exposure. f/5 is faster than f/10. The faster the ratio, the faster exposure time is needed when a camera is hooked up to the telescope. Your telescope has slower focal ratio at f/8. Sometimes, astronomers use focal reducers to make slow exposure telescopes have faster focal ratios.

### USE THE SPECIFICATIONS TO CALCULATE THE MAGNIFICATION OF YOUR EYEPIECE

The power of a telescope is how much it magnifies objects. Your 25mm eyepiece magnifies an object 36 times. Your 9mm eyepiece magnifies objects 100 times. But if

you obtain other eyepieces, you can calculate how much magnification they have with your telescope. Just divide the focal length of the telescope by the focal length of the eyepiece.

$$\begin{array}{r} \text{Focal Length of the Telescope} \\ \div \\ \text{Focal Length of the Eyepiece} \\ = \\ \text{Magnification} \end{array}$$

Look at the specifications. You will see that the focal length of your scope is 900mm. Let’s say that you have obtained a 13mm eyepiece. You can tell that what the focal length of your eyepiece is as it is always printed on the side or top of an eyepiece. Divide:  $900 \div 13$ , which equals 69.2. Round this off to the nearest whole number and your new eyepiece magnifies objects 69 times.

If you use a Barlow lens with one of your eyepieces, it doubles the magnification of your eyepiece. Other types of Barlows can triple or further increase the power of an eyepiece. To find out how much your magnification is when you use a Barlow,

#### ASTRONOMY RESOURCES

- Astronomical League  
Executive Secretary  
5675 Real del Norte, Las Cruces, NM 88012
- The Astronomical Society of the Pacific  
390 Ashton Ave., San Francisco, CA 94112
- The Planetary Society  
65 North Catalina Ave, Pasadena, CA 91106
- International Dark-Sky Association, Inc.  
3225 N. First Avenue, Tucson, AZ 85719-2103



Looking at or near the **Sun** will cause **irreversible** damage to your eye. Do not point this telescope at or near the Sun. Do not look through the telescope as it is moving.

multiply your eyepiece's magnification by two.

Your 25mm low-power eyepiece magnifies an object 36 times. Multiply 36 by 2 and you get 72 times magnification with a Barlow.

$$\text{Eyepiece's magnification} \times 2 =$$

Magnification with a 2X Barlow lens

**It's worth repeating:** Keep in mind that a bright, clear, but smaller image is more interesting than a larger, dimmer, fuzzy one. Using too high a power eyepiece is one of the most common mistakes made by new astronomers. So don't think that higher magnification is necessarily better—quite often the best view is with lower magnification value!

## TAKING CARE OF YOUR TELESCOPE

Your telescope is a precision optical instrument designed for a lifetime of

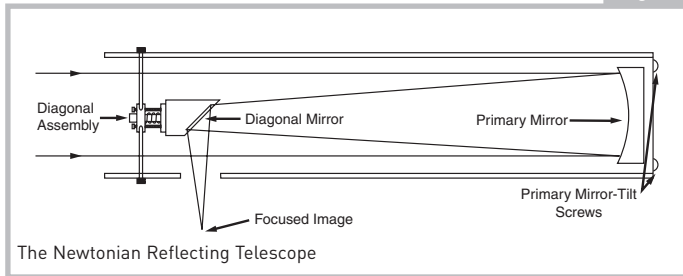

Fig. 11

rewarding viewing. It will rarely, if ever, require factory servicing or maintenance. Follow these guidelines to keep your telescope in the best condition:

- As with any quality instrument, lens or mirror surfaces should be cleaned as infrequently as possible. Front surface aluminized mirrors, in particular, should be cleaned only when absolutely necessary. In all cases avoid touching any mirror surface. A little dust on the surface of a mirror or lens causes negligible loss of performance and should not be considered reason to clean the surface. When lens or mirror cleaning does

become necessary, use a camel's hair brush or compressed air gently to remove dust. If the telescope's dust cover is replaced after each observing session, cleaning of the optics will rarely be required.

- Fingerprints and organic materials on the lens or mirror may be removed with a solution of 3 parts distilled water to 1 part isopropyl alcohol. You may also add 1 drop of biodegradable dishwashing soap per pint of solution. Use soft, white facial tissues and make short, gentle strokes. Change tissues often.

**CAUTION:** Do not use scented or lotioned tissues or damage could result to the optics. DO NOT use a commercial photographic lens cleaner.

## COLLIMATION (ALIGNMENT) OF OPTICS

All Meade 114 EQ-AR telescopes are optically aligned at the factory prior to shipment. It is unlikely that you will need to align, or collimate, the optics after receipt of the instrument. However, if the telescope



Looking at or near the **Sun** will cause **irreversible** damage to your eye. Do not point this telescope at or near the Sun. Do not look through the telescope as it is moving.

received unusually rough handling in shipment, it is possible that the optics must be re aligned for best optical performance. In any case this alignment procedure is simple, and requires only a few minutes the very first time the telescope is used. Take the time to familiarize yourself with the following collimation procedure, so that you will recognize a properly collimated instrument and can adjust the collimation yourself, if necessary.

### A. CORRECT COLLIMATION

The properly collimated (aligned) mirror system in the Meade 114 EQ-AR assures the sharpest images possible. This occurs when the primary mirror and diagonal mirror are tilted so that the focused image falls directly through the center of the focuser drawtube. These mirror tilt adjustments are made with the diagonal assembly and the primary mirror cell (Fig. 11) and will be discussed later.

To inspect the view of the mirror collimation, look down the focuser drawtube with the eyepiece removed. The edge of the focuser drawtube (1, Fig. 14), will frame the reflections of the primary mirror with the 3

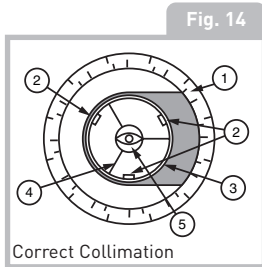

illustrated in Fig. 14.

Any deviation from the concentric reflections will require adjustments to the diagonal assembly and/or the primary mirror cell (Fig. 11).

### B. DIAGONAL HOLDER ADJUSTMENTS

If the diagonal mirror (1, Fig. 15) is centered in the drawtube (2, Fig. 15), but the primary mirror is only partially visible in the reflection (3, Fig. 15), the 3 Phillips-head diagonal tilt screws must be unthreaded slightly to the point of where you can tilt the diagonal holder from side-to-side by grasping the diagonal holder with your hand and tilt until you see the primary mirror

mirror clips (2, Fig. 14), the diagonal mirror (3, Fig. 14), the spider vanes (4, Fig. 14), and your eye (5, Fig. 14). Properly aligned, all of these reflections will appear concentric (i.e., centered) as

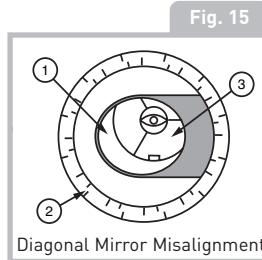

to lock the rotational position. Then, if necessary, make adjustments to these 3

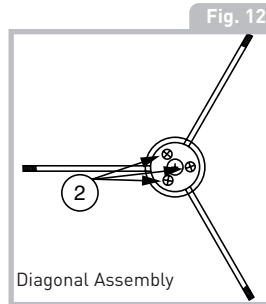

The primary mirror is shown out of alignment).

become as centered in the reflection of the diagonal mirror as possible. Once you are at the best position, thread in the 3 Phillips-head diagonal tilt screws to lock the rotational position. Then, if necessary, make adjustments to these 3 Phillips-head screws to refine the tilt-angle of the diagonal mirror until the entire primary mirror can be seen centered within the diagonal mirror reflecting. When the diagonal mirror is correctly aligned, it will look like Fig. 15 (Note:



Looking at or near the **Sun** will cause **irreversible** damage to your eye. Do not point this telescope at or near the Sun. Do not look through the telescope as it is moving.

## C. PRIMARY MIRROR ADJUSTMENTS

If the diagonal mirror (1, Fig. 16) and the reflection of the primary mirror (2, Fig.

Fig. 16

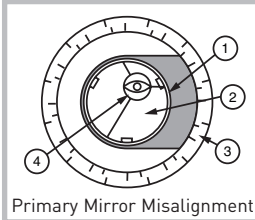

16) appear centered within the drawtube (3, Fig. 16), but the reflection of your eye and the reflection of the diagonal mirror (4, Fig. 16) appear off center, you will need

to adjust the primary mirror tilt Phillips-head screws of the primary mirror cell (3, Fig. 13). These primary tilt screws are located behind the primary mirror, at the lower end of the main tube. To adjust the primary

Fig. 13

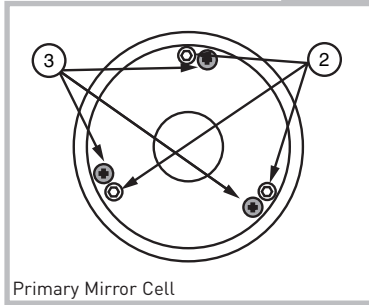

mirror tilt screws, first unscrew several turns, the 3 hex-head primary mirror cell locking screws (2, Fig. 13) that are next to each primary mirror tilt Phillips-head screw. Then by trial-and-error, turn the primary mirror tilt Phillips-head screws (3, Fig. 13) until you develop a feel for which way to turn each screw to center the reflection of your eye. Once centered, as in Fig. 14, turn the 3 hex-head primary mirror cell locking screws (2, Fig. 13) to relock the tilt-angle adjustment.

## D. STAR TESTING THE COLLIMATION

With the collimation performed, you will want to test the accuracy of the alignment on a star. Use the 25mm eyepiece and point the telescope at a moderately bright (second or third magnitude) star, then center the star image in the telescope's field-of-view. With the star centered follow the method below:

- Bring the star

image slowly out of focus until one or more rings are visible around the central disc. If the collimation was performed correctly, the central star disk and rings will be concentric circles, with a dark spot dead center within the out-of-focus star disk (this is the shadow of the secondary mirror), as shown in Fig. 17C. (An improperly aligned telescope will reveal elongated circles (Fig. 17A), with an off-center dark shadow.)

- If the out-of-focus star disk appears elongated (Fig. 17A), you will need to adjust the primary mirror Phillips-head tilt screws of the primary mirror cell (3, Fig. 13)

Fig. 17

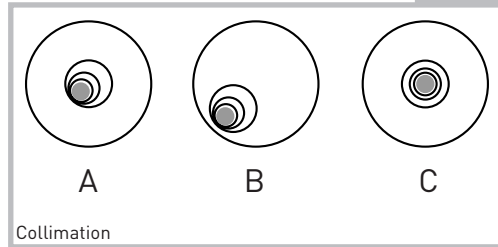

- To adjust the primary mirror tilt screws (3, Fig. 13), first unscrew several turns the 3 hex-head primary mirror cell locking screws (2, Fig. 13), to allow free turning movement of the tilt knobs.



- Using the flexible cable controls move the telescope until the star image is at the edge of the field-of-view in the eyepiece, as in Fig. 17B.
- As you make adjustments to the primary mirror tilt screws (3, Fig. 13), you will notice that the out-of-focus star disk image will move across the eyepiece field. Choose one of the 3 primary mirror tilt screws and slightly move the shadow to the center of the disk. Then slightly move the telescope using the flexible cable controls to center the star disk image in the center of the eyepiece.
- If any further adjustments are necessary, repeat this process as many times as needed until the out-of-focus star disk appears as in Fig. 17C, when the star disk image is in the center of the eyepiece field.
- With the star testing of the collimation complete, tighten the 3 hex-head primary mirror locking screws (2, Fig. 13)

## OPTIONAL ACCESSORIES

### **Additional Eyepieces (1.25" barrel diameter):**

For higher or lower magnifications with the telescopes that accommodate 1.25" eyepieces, Meade Series 4000 Super Plössl eyepieces, available in a wide variety of sizes, provide a high level of image resolution and color correction at an economical price. Contact your Meade Dealer or see the Meade catalog for more information. Visit us on the web at [www.meade.com](http://www.meade.com).

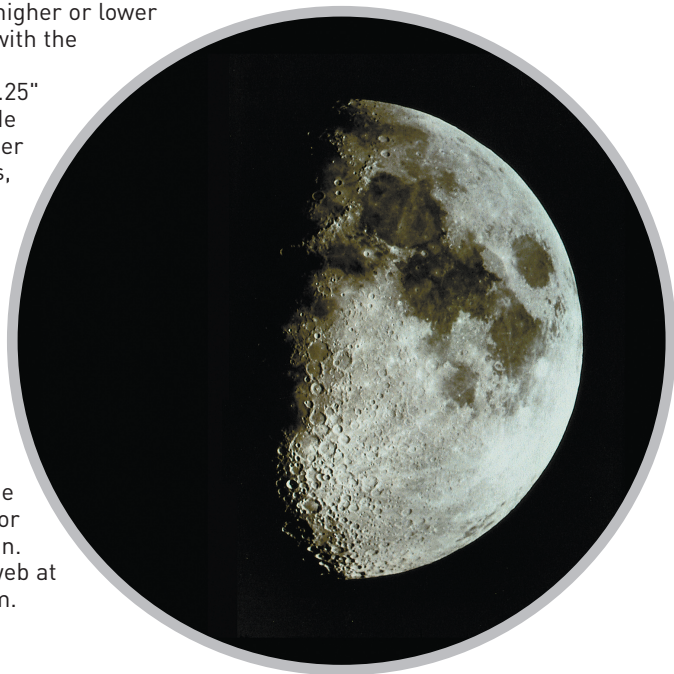

## MEADE CONSUMER SOLUTIONS

If you have a question concerning your telescope, call Meade Instruments Consumer Solutions Department at (800) 626-3233. Consumer Solutions Department hours are 8:00AM to 5:00PM, Pacific Time, Monday through Friday. Write or call the Meade Consumer Solutions Department first, before returning the telescope to the factory, giving full particulars as to the nature of the problem, as well as your name, address, and daytime telephone number. The great majority of servicing issues can be resolved by telephone, avoiding return of the telescope to the factory.

## MEADE LIMITED WARRANTY

Every Telesar telescope, spotting scope, and telescope accessory is warranted by Meade Instruments Corporation ("Meade") to be free of defects in materials and workmanship for a of ONE YEAR from the date of original purchase in the U.S.A. Meade will repair or replace a product, or part thereof, found by Meade to be defective, provided the defective part is returned to

Meade, freight-prepaid, with proof of purchase. This warranty applies to the original purchaser only and is non-transferable. Meade products purchased outside North America are not included in this warranty, but are covered under separate warranties issued by Meade international distributors.

**RG Number Required:** Prior to the return of any product or part, a Return Goods Authorization (RGA) number **must** be obtained from Meade by writing, or by calling (800) 626-3233. Each returned part or product must include a written statement detailing the nature of the claimed defect, as well as the owner's name, address, and phone number.

This warranty is not valid in cases where the product has been abused or mishandled, where unauthorized repairs have been attempted or performed, or where depreciation of the product is due to normal wear-and-tear. Meade specifically disclaims special, indirect, or consequential damages or lost profit which may result from a breach of this warranty. Any implied warranties

which cannot be disclaimed are hereby limited to a term of one year from the date of original retail purchase.

This warranty gives you specific rights. You may have other rights which vary from state to state.

Meade reserves the right to change product specifications or to discontinue products without notice.

This warranty supersedes all previous Meade product warranties.

# OBSERVATION LOG

OBSERVER: \_\_\_\_\_

OBJECT NAME: \_\_\_\_\_

DATE & TIME OBSERVED: \_\_\_\_\_

CONSTELLATION: \_\_\_\_\_

EYEPIECE SIZE: \_\_\_\_\_

SEEING CONDITIONS:     EXCELLENT     GOOD     POOR

NOTES: \_\_\_\_\_

\_\_\_\_\_

\_\_\_\_\_

\_\_\_\_\_



\_\_\_\_\_

\_\_\_\_\_

\_\_\_\_\_

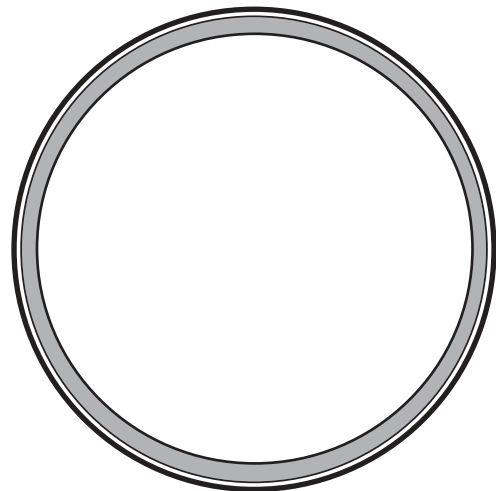

DRAWING OF IMAGE

# OBSERVATION LOG

OBSERVER: \_\_\_\_\_

OBJECT NAME: \_\_\_\_\_

DATE & TIME OBSERVED: \_\_\_\_\_

CONSTELLATION: \_\_\_\_\_

EYEPiece SIZE: \_\_\_\_\_

SEEING CONDITIONS:     EXCELLENT     GOOD     POOR

NOTES: \_\_\_\_\_

\_\_\_\_\_

\_\_\_\_\_

\_\_\_\_\_



\_\_\_\_\_

\_\_\_\_\_

\_\_\_\_\_

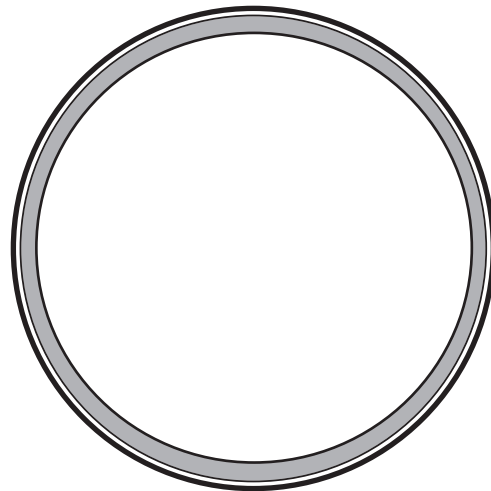

DRAWING OF IMAGE



# OBSERVATION LOG

OBSERVER: \_\_\_\_\_

OBJECT NAME: \_\_\_\_\_

DATE & TIME OBSERVED: \_\_\_\_\_

CONSTELLATION: \_\_\_\_\_

EYEPIECE SIZE: \_\_\_\_\_

SEEING CONDITIONS:     EXCELLENT     GOOD     POOR

NOTES: \_\_\_\_\_

\_\_\_\_\_

\_\_\_\_\_

\_\_\_\_\_



\_\_\_\_\_

\_\_\_\_\_

\_\_\_\_\_

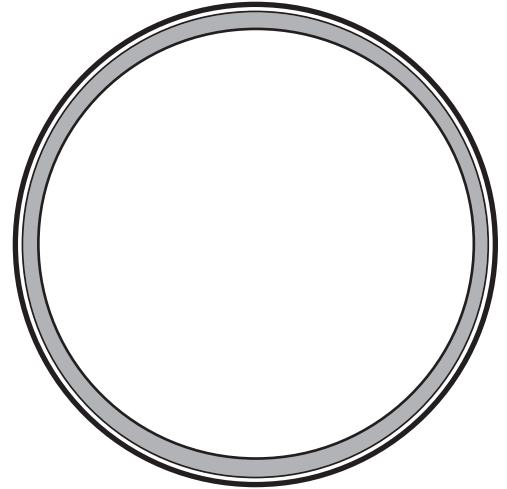

DRAWING OF IMAGE

# OBSERVATION LOG

OBSERVER: \_\_\_\_\_

OBJECT NAME: \_\_\_\_\_

DATE & TIME OBSERVED: \_\_\_\_\_

CONSTELLATION: \_\_\_\_\_

EYEPIECE SIZE: \_\_\_\_\_

SEEING CONDITIONS:     EXCELLENT     GOOD     POOR

NOTES: \_\_\_\_\_

\_\_\_\_\_

\_\_\_\_\_

\_\_\_\_\_



\_\_\_\_\_

\_\_\_\_\_

\_\_\_\_\_

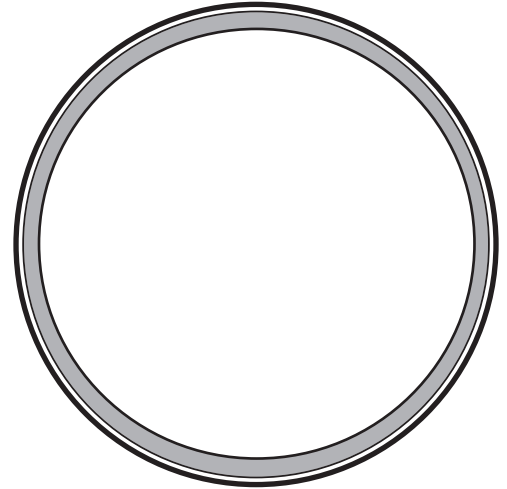

DRAWING OF IMAGE



1-800 626-3233

Meade Instruments Corporation  
27 Hubble, Irvine, California

92618

[www.meade.com](http://www.meade.com)