



Instruction Manual

LX65 Series Telescopes with AudioStar





WARNING!

Never use an unfiltered telescope to look at the Sun! Looking at or near the Sun will cause instant and irreversible damage to your eye. Eye damage is often painless, so there is no warning to the observer that damage has occurred until it is too late. Do not point the telescope at or near the Sun. Do not look through the telescope or Red Dot Finder as it is moving. Children should always have adult supervision while observing.

BATTERY SAFETY INSTRUCTIONS:

- Always purchase the correct size and grade of battery:
8 x "C-type" Alkaline batteries (ANSI 14A, 14AC/
IEC LR14).
- Always replace the whole set of batteries at one time, taking care not to mix old and new ones, or batteries of different types.
- Clean the battery contacts and also those of the device prior to battery installation.
- Ensure the batteries are installed correctly with regard to polarity (+ and -).
- Remove batteries from equipment which is not to be used for an extended period of time.
- Remove used batteries promptly.
- Never attempt to recharge primary batteries as this may cause leakage, fire, or explosion.
- Never short-circuit batteries as this may lead to high temperatures, leakage, or explosion.
- Never heat batteries in order to revive them.
- Remember to switch off devices after use.
- Keep batteries out of the reach of children; small batteries may be ingested.
- Seek medical advice immediately if a battery has
been swallowed.

Caution: If batteries or parts are swallowed, see a doctor immediately.

CONTENTS

Introduction

A solid telescope built for a lifetime of service 4

Getting Started

Assembling the and Using the LX65 Telescope	
Assembling the Tripod	5
Mounting the Tripod	6
Installing the Batteries.	6
Using an AC Adapter or DC Power Cord	6
Attaching Accessories	7
Telescope is now Fully Assembled	8
Using the Red Dot Finder	8
Adjusting the Red Dot Finder	8
Aligning the Telescope	9
The Telescope Home Position	9
Magnetic North Home Position.	9
True North Home Position.	9
Moving Through AudioStar's Menus.	10
Initializing AudioStar	10
Easy (Two-Star) Align	11
How to Perform the Easy Align Procedure	11
Go To Saturn.	12
Using the Guided Tour	12

LX65 Key Features

Telescope	
Key Features Identified on the Telescope.	13
Key Features Explained	15
Choosing Eyepieces	16
AudioStar Handbook – Basic Usage	
Buttons, Display and their functions.	17
Observing Using AudioStars' Keys.	19
Playing the Audio	20
LX65 Tips	20
AudioStar Operation	
AudioStar Navigation Exercise	21
Entering Data into AudioStar	22
Guided Tour Menu	24
Object Menu	24
AudioStar Menu Tree	23
Event Menu.	24
Glossary Menu	25
Utilities Menu	25
Setup Menu.	28

Advanced AudioStar Features

Adding Observing Sites	29
Finding Objects Not In the Database	30
GoTo a User-entered Object	32
Observing Satellites	32
How to Create Your Own Guided Tour	33
Writing a Tour	34
Landmarks	37
Identify	38
Advanced Alignment.	36
Two-Star Alt/Az Alignment	36
One-Star Alt/Az Alignment	38
Browse	38

Maintenance

Basic Maintenance	39
Collimation	39
Inspecting the Optics	41
Gaging the Movement of the Telescope.	41
Updating Your LX65 Firmware	41

Meade Customer Service

How to get in contact	43
---------------------------------	----

Appendix A:

Training the Drive	44
------------------------------	----

Appendix B:

Basic Astronomy.	43
--------------------------	----

Appendix C:

Specifications	45
--------------------------	----

Appendix D:

LX65 Optical Systems.	49
-------------------------------	----

Appendix E:

Using the LX65 With Two Optical Tubes.	50
--	----

Contact Information

Social Media and Address	Back Cover
------------------------------------	------------

® The name “Meade,” “AudioStar” and the Meade logo are trademarks registered with the U.S. Patent and Trademark Office and in principal countries throughout the world. “Deep Sky Imager” and “Tonight’s Best” are trademarks of Meade Instruments Corp.

Patents:

US 7,277,223, US 7,079,317, US 7,092,156

US 6,304,376, US 6,369,942, US 6,392,799

© 2018 Meade Instruments Corp.

INTRODUCTION

The LX65 Series Telescope

A solid telescope built for a lifetime of service

Congratulations on receiving your new LX65 telescope. You'll find that this telescope system has all you need to explore the Universe we live in. Meade's concept was to create a telescope that would be simple enough for anyone to use, yet capable enough for the experienced amateur to stretch their knowledge and skills. With the LX65's advanced set of features, you will have plenty of room to learn and expand your interest in astronomy and not outgrow your telescope. Here are a few of the features that set the Meade LX65 telescope system apart from all others.

- Optics: Your choice of optical systems to meet your needs. Meade's Advanced Coma-Free (ACF) and Maksutov-Cassegrain (MC) optics give you high performance for the best possible price. Water-white glass, Ultra-High Transmission Coatings (UHTC) and oversized, thermally-stable borosilicate primary mirrors provide spectacular viewing experience no matter where you observe. Meade optics offers the ideal solution for the serious astroimager or visual astronomer looking for observatory-class optics.
- Mechanics: Strong and stable aluminum castings with large precision worm-gear drives in both axes for smooth tracking and improved rigidity. Vixen-style dovetail receivers and secondary saddle makes the Meade LX65 system ideal for sharing the night sky.
- Computer: AudioStar handbox gives you complete control of your LX65 system from the palm of your hand. With a database of over 30,000 objects, you will never run out of things to explore.

If you are like us, you can't wait to get outside under a dark sky to try out your new LX65 telescope. We have provided a Getting Started Guide that will get you up and running in the shortest amount of time possible. After your first experience, please sit down with this manual and read about all the advanced features that are available to you with this telescope system. We are confident that the LX65 will keep you fascinated with the Universe and entertained for many years to come.

Clear Skies,

The people at Meade

GETTING STARTED

You may want to perform the telescope assembly indoors in the light so that you become familiar with the parts and operation before moving the telescope outside into the dark for observing. This Getting Started Guide provides a brief overview so you can use your new telescope as quickly as possible. Just follow the simple steps below and you will be up and running before you know it.

1 Set the telescope in a large open area where you can see lots of sky. Don't setup right next to a building or a wall. Make sure the ground is stable and is approximately level. It is best to set up the scope away from bright nighttime lighting. Bright lights will spoil your night vision and impede your ability to see the sky.



Assembling the Tripod

2 Remove the field tripod from the shipping carton. Stand the tripod vertically with the tripod feet down and with the tripod still fully collapsed. Grasp two of the tripod legs and, with the full weight of the tripod on the third leg, gently pull the legs apart to a fully open position.

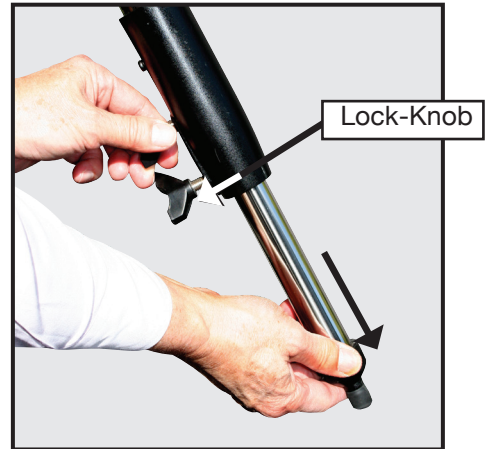

3 Thread in the lock-knobs on each leg near the foot of each tripod leg. Use the lock-knobs to vary the height of the inner, extendible tripod leg sections. Tighten the locks to a firm feel only; do not overtighten.

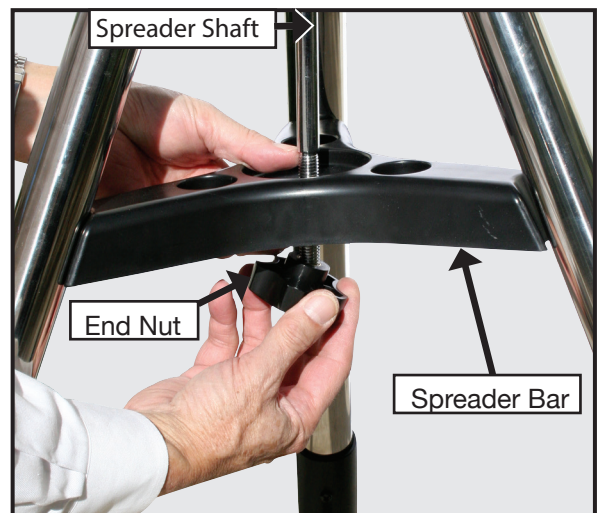

4 Remove the end nut from the spreader shaft and slide the spreader in between the telescope legs. Attach the end nut and hand tighten until the telescope legs are held snugly in the most spread position. Position the tripod where you want the telescope to be and check that the top of the tripod is approximately level.

Mounting the Telescope

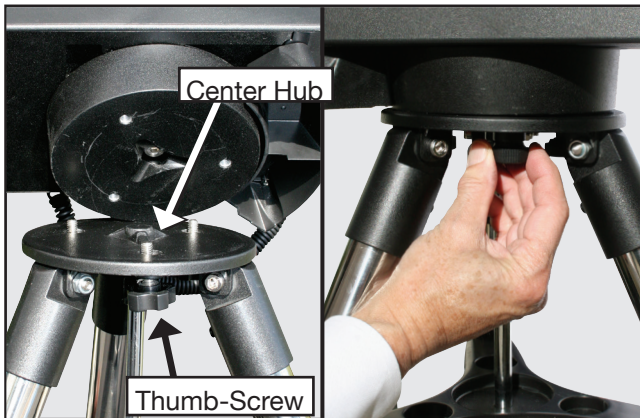

5 Take the LX65 from its packaging and place the entire telescope onto the top of the tripod head. Rotate the telescope head slowly until you feel the scope register on the center hub of the tripod head. Carefully screw the three attachment thumb-screws on the bottom of the plate to the base of the tripod. Hand tighten the screws so the telescope cannot spin or wobble on the tripod head.

Installing the Batteries



6 Remove the end cover from the battery compartment exposing the battery tray. Carefully slide the battery tray out until it reaches its end stop. Insert 8 (user supplied) Alkaline “C” batteries into the battery compartment. Take care that the batteries + and - ends are as indicated in the battery holder.

Slide the battery compartment back into the telescope and re-attach the battery compartment cover.

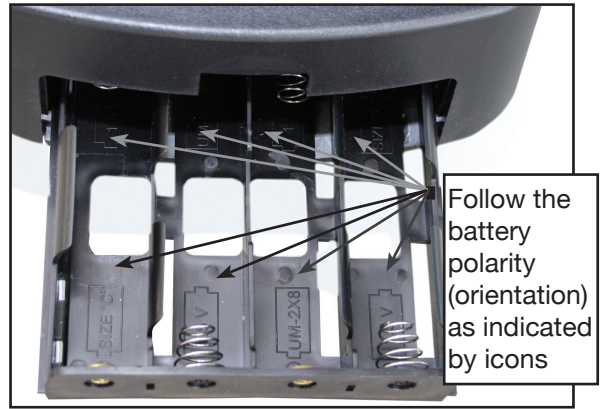

CAUTION: Follow battery manufacturer’s precautions. Do not install batteries backwards or mix new and used batteries. Do not mix battery types. If these precautions are not followed, batteries may explode, catch fire, or leak. Improperly installed batteries void your Meade warranty. Always remove the batteries if they will not be used for a long period of time.

Using an AC Adapter or DC Power Cord

7 Use only the optional Meade Universal AC Power Adapter (part number 07584) with your LX65 telescope



when connecting to AC power. Power adapters from other manufactures may cause damage and void your warranty.

Plug the AC plug into an AC household socket or the DC plug into the 12v DC socket on the telescope panel.

For external DC power use the optional #607 DC Power Cord (part number 07043) to connect to an automotive 12v DC accessory socket.

Attaching Accessories



8 Be sure the telescope power switch is in the off position. Remove the handbox and the coiled interface cable from the packing materials. Plug one end into the HBX port of the control panel and plug the other end into the Handbox port on the LX65 handbox.



9 Loosen the Dovetail Locking Knob slightly. Carefully place the telescope optical tube's dovetail into the dovetail saddle on the LX65's fork mount, then tighten the Dovetail Locking Knob. When standing behind the LX65 facing the control panel, the optical tube should be on the right hand side of the fork mount.

To balance the telescope in altitude, carefully loosen the Altitude Clutch Knob while holding onto the optical tube. If the optical tube is front or back heavy, slightly loosen the Dovetail Locking Knob and slide the optical tube forward or backward as needed to reach balance. Use caution and never let go of the optical tube during this process. Make sure the optical tube is securely attached before letting go.

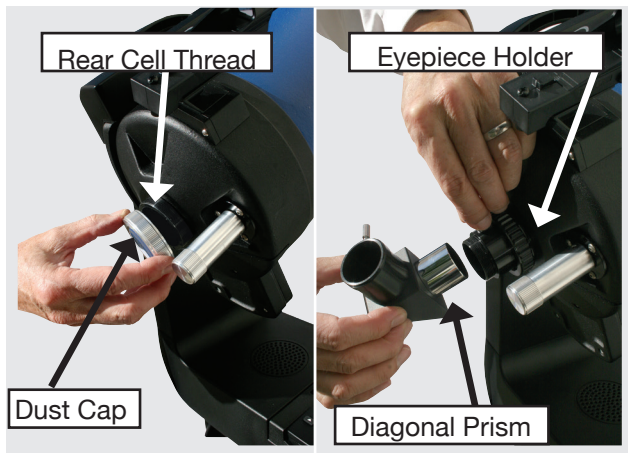

On the optical tube, remove the dust cap from the rear cell of the telescope. Thread the 1.25" eyepiece holder onto the rear cell thread. Slide the diagonal mirror into the eyepiece holder and lock in place by turning the thumbscrew to a firm feel. Place the Super Plössl 26mm eyepiece into the diagonal mirror and tighten the diagonal mirror thumbscrew to a firm feel only.

10 Remove the dust cover from the front of the optical tube. Be careful not to touch the glass lens.

11 Now install the Red Dot Finder onto the optical tube by sliding the finder's base into the pre-installed mounting bracket on top of the OTA. Tighten the mounting base thumbscrew to a firm feel. Use of the red dot finder is described in the next section.

12 Flip the Power Switch on the computer control panel to the ON position. The copyright message lights on AudioStar's LCD display, followed by the "Press 0 to Align or MODE for Menu" display.

13 "Press 0 to align or Mode for Menu" displays. You can use the Arrow keys to slew (move) the telescope up, down, right, or left. To change the telescope's slew speed, press a Number key. "9" is the fastest speed and "1" is the slowest speed. Or you can Press "0" to begin Easy Alignment. See page 11 for more information.

Your Telescope is Now Fully Assembled

Congratulations, your LX65 is now assembled and you are nearly ready to begin observing! Please follow the next steps to align your telescope so you can start locating objects in the night sky with the push of a button using AudioStar. Once you become familiar with the following alignment procedures, your overall setup time will be just a few minutes.

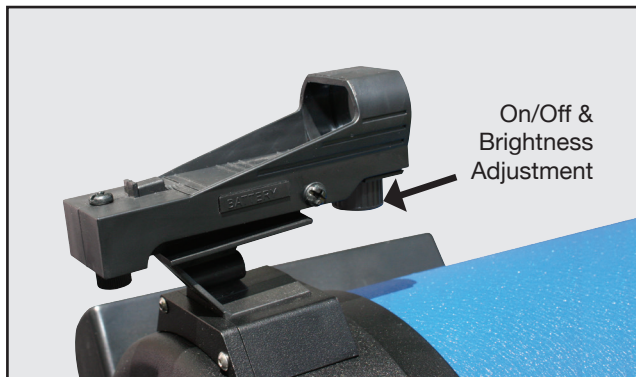

Using the Red Dot Finder

Because your telescope has so much magnification, its field of view is very small. This can make it hard to know exactly where your telescope is pointing by simply looking at it. To help you point the telescope quickly and accurately, the LX65 has a 1X Red Dot Viewfinder.

It works much like a fighter pilot's heads-up display. To turn on the Red Dot Finder, carefully rotate the power switch until you feel it click on. Turning further clockwise will increase the dot brightness. Adjust the dot to the minimum brightness where it can be easily seen. This will extend its battery life and make it easier to see faint stars in the background. Look through the finder's glass window. You will see a red dot superimposed on your view. Using the direction keys on the handbox, move the telescope until the red dot is on the target you want to view in the eyepiece. As you get close to your target, select a moderately low speed, like speed 5, and move the scope to center your target as you look through the eyepiece. This is a great way to get used to finding the movement keys without removing your eye from the eyepiece.

Adjusting the Red Dot Finder



The Red dot finder needs to be aligned with your telescope so both precisely point to the same object. To do this, look through the eyepiece of your scope and using the hand box center a distant object. Now turn on the Red Dot Viewfinder and adjust the brightness so you can see the red dot. Look through the sight as pictured above.

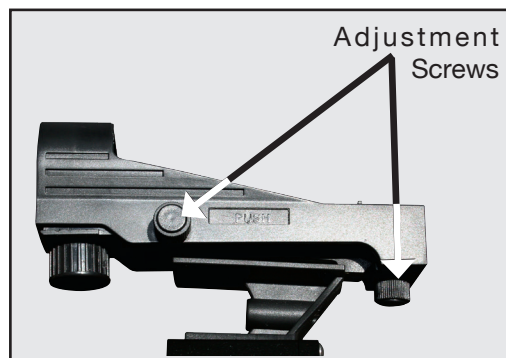

Now, without moving the telescope, adjust the indicated thumb screws until you have put the red dot on the object at which you were looking. It's that simple.

Now use the hand controller to put the laser dot on a new target. Check to see that the desired target is in the eyepiece and adjust the focus knob until the object is in focus.

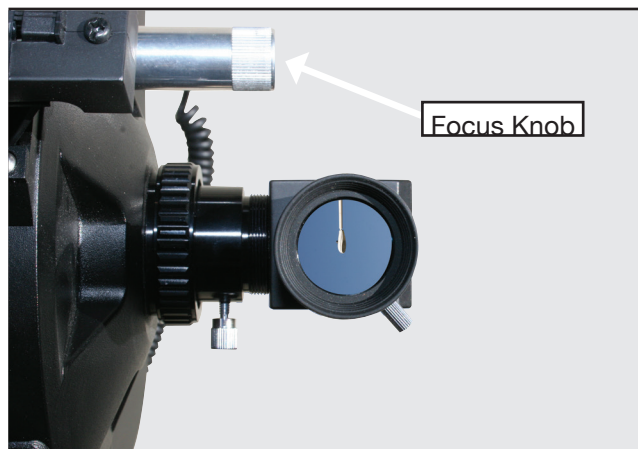

Aligning the Telescope

As the Earth rotates beneath the night sky, the stars appear to move from East to West. The speed at which the stars move is called the sidereal rate. You can setup your telescope to move at the sidereal rate so that it automatically tracks the stars and other objects in the night sky. If the telescope is not tracking an astronomical object, the object will drift out of the eyepiece field of view. The tracking function automatically keeps an object more or less centered in the telescope's eyepiece.

To automatically track and locate objects in the night sky, the LX65 telescope must first be aligned on the sky. It is best to set up the telescope in twilight or before sunset the first time you use the LX65 telescope. Setup the telescope in a large open area where you can see lots of the night sky. Make sure the ground is stable and approximately level. It is best to setup the scope away from bright nighttime lighting. Bright lights will spoil your night vision and impede you ability to see the sky.

The Telescope Home Position

Once the telescope is fully assembled, you will first need to initialize AudioStar, set the telescope into the home position, and perform the Easy Alignment in order for the telescope to successfully locate celestial objects. The home position for the LX65 series is with the telescope optical tube level and pointed in the direction of either True North or Magnetic North. Either North direction can be used and the AudioStar will prompt you to which North direction the optical tube is pointing before beginning an alignment. Once the telescope is fully assembled and outside under the night sky, follow the steps below to correctly place the telescope into the home position.

Magnetic North Home Position

1. Using the up/down arrow keys on the AudioStar controller, move the telescope so that the optical tube is approximately level. Place the included bubble level/compass into the diagonal mirror and use the AudioStar left/right arrow keys to move the telescope so the optical tube is lined up with the compass needle. The telescope will then be pointing in the direction of Magnetic North.

2. Now use the up/down arrow keys on the AudioStar controller to level the optical tube using bubble level feature to precisely level the optical tube.

3. The telescope is now in the Magnetic North Home Position.

True North Home Position

1. Using the up/down arrow keys on the AudioStar controller, move the telescope so that the optical tube is approximately level. Now use the left/right arrow keys to move the telescope so the optical tube is pointing in the direction of True North (the north star Polaris).

2. Now use the up/down arrow keys on the AudioStar controller to level the optical tube. The included bubble level/compass can be placed into the diagonal mirror and has a built in bubble level feature that will aide in leveling the optical tube if needed.

3. The telescope is now in the True North Home Position.

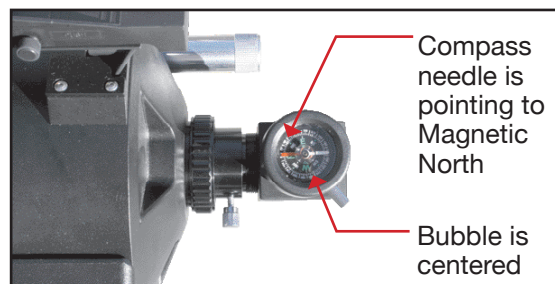
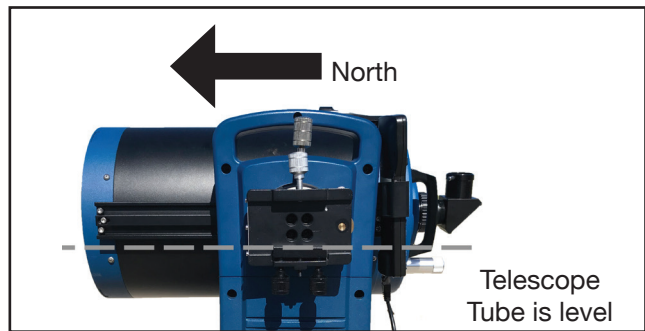

Moving Through AudioStar's Menus

The AudioStar database is organized in levels for quick and easy navigation.

- Press ENTER to go deeper into AudioStar's menu levels.
- Press MODE to move back toward the top menu level.
- Press the Scroll keys to move up and down through the options available for each level.
- Press the Arrow keys to enter characters and digits.

The Arrow keys are also used to move the telescope.

Initializing AudioStar

This section describes how to initialize AudioStar. Perform this procedure the first time you use AudioStar or after performing a RESET (page 28).

1. Verify that AudioStar is properly connected to your telescope (see step 8 on page 7).
2. Turn the telescope power switch to the ON position.

The AudioStar beeps and the display screen is activated. Then AudioStar takes a few moments to start up the system.

3. "Press 0 to Align or Mode for Menu" displays. Press 0 to align your telescope using the "Easy Align" method, see "Easy (Two-Star) Align" on page 11. To skip the alignment process and access the AudioStar menus, press the Mode key.
4. The telescope then tests the motor function of the telescope by moving in the horizontal and vertical directions.
5. Set Your Location or Zip Code: The Location screen displays. This screen asks you if you wish to choose either the zip code of your observing location or the location (i.e., entering the city and state or country of your observing location). Press "1" to select the zip code option or "2" to enter the city and state.

Note: The location settings (country/state/province and city, or zip code) are only asked for the first time you turn on the control panel. If you wish to change this setting later on, use the Site menu.

- a. If you chose the zip code option, the left most "0" is highlighted. Use the Number keys to enter the digits. As you enter a digit, the next digit to the right will be highlighted. Enter the next digit. Repeat this process until all 5 digits of your zip code are entered. Press ENTER.
- b. If you chose the location option, the next screen asks for the country or state/province (listed alphabetically) of the observing site.
- c. Use the Scroll keys to scroll through the list of countries, states, and provinces. Press ENTER when the correct location displays.
- d. The next screen asks for the city (listed alphabetically) closest to the observing site. Use the Scroll keys to scroll through the list of cities. Press ENTER when the correct city appears on screen.

6. The next screen requests the status of Daylight Savings Time. If Daylight Savings Time is active, press the "1" key. If Daylight Savings Time is not active, press the "2" key.

Note: Daylight Savings Time may be referred to by a different name in various areas of the world.

7. AudioStar then asks for the Telescope Model. Using the scroll keys on the AudioStar locate the model of your telescope and press enter.
8. Now enter the current date, then press ENTER.
9. Enter the current time. Select "AM," "PM," or 24-hour clock (blank). Then press ENTER.
10. System initialization is now complete and AudioStar enters into the Easy Alignment routine. The AudioStar display now reads "North Method, 1=True 2= Compass". See "Easy (Two-Star) Alignment" for performing an alignment on the night sky. If you do not wish to begin an alignment on the night sky, press the MODE key to exit to the main AudioStar menu.

Easy (Two-Star) Align

The fastest and easiest way to locate objects with AudioStar's GO TO capabilities is to use Easy Align.

AudioStar automatically picks two stars from its database for the Easy Align procedure. During this procedure, AudioStar slews the telescope to a first alignment star. The user is asked to verify that the telescope is pointed at the chosen star and then prompted to center the star in the eyepiece. The process is repeated with a second star to complete the alignment.

Note: Before aligning the telescope, first verify that "INITIALIZING AudioStar", page 10, has been performed. See "Moving through AudioStar's Menus", page 10, for a description of how AudioStar's keys operate.

How to perform the Easy Align Procedure

If you have just powered on the telescope, follow the procedures listed in "Initializing AudioStar" on page 10. When completed, continue on to the steps below to perform the Easy Alignment procedure. If the telescope is already powered on and the correct site location, date, time and telescope model have already been entered, the Easy Alignment can be started by selecting in the menu Setup: Align: Easy and following the steps below.

1. When the Easy Alignment procedure is selected in the AudioStar's setup menu, the display will read "North Method: 1=True 2=Compass". AudioStar is asking which Home Position the telescope will be placed in. See page 9, "The LX65 Home Position" for a description on placing the LX65 telescope into the home position.

Note: The easiest way to set the telescope in the home position is using the Magnetic North method. Follow the steps on page 9 "Magnetic North Home Position" and press the "2" key on AudioStar to select the "Compass" (Magnetic North) method.

2. Star Alignment - The AudioStar then chooses two stars to align upon. When the telescope slews to the first star for alignment, it may not appear in the field of view in the eyepiece.

The alignment star should be easily recognized and be the brightest star in the area of the sky where the telescope is pointing. While looking through the red dot finder, use the Arrow Keys to move the telescope to place the red dot on the top of the star. Now look through the eyepiece and use the Arrow Keys to move the star to the center of the eyepiece field. Press ENTER. If that area of the sky is obscured by an object, you can prompt AudioStar to choose an alternate star by pressing either one of the two Scroll Keys. Repeat procedure for the second alignment star.

When the procedure is performed correctly, "Alignment Successful" displays. If AudioStar does not display this message, perform this procedure again.

NOTE: AudioStar locates alignment stars based on the date, time, and location entered. The alignment stars may change from night to night. All that is required is for the observer to center the selected stars in the eyepiece when prompted.

NOTE: The GO TO key also allows you to perform a "spiral search". A spiral search is useful when the telescope slews to an object, but that object is not visible in the eyepiece after the telescope finishes its search. (This sometimes occurs during an alignment procedure.) Press GO TO when the slew is finished and the telescope starts slewing in a spiral pattern at a very slow speed around the search area. Look through the eyepiece and when the object does become visible, press MODE to stop the spiral search. Then use the Arrow keys to center the object.

Which One's the Alignment Star?

If you're not familiar with objects in the night sky, how can you be sure if the star in your eyepiece is really the alignment star?

The rule of thumb is that an alignment star is usually the brightest star in that area of the sky. If you perform a GoTo to an alignment star and you're not sure if you have located the alignment star or it isn't in the eyepiece, look through your viewfinder. When you view an alignment star in the viewfinder, it stands out dramatically from the rest of the stars in that portion of the sky.

The viewfinder will help you locate a star more quickly than the eyepiece. Using AudioStar, set the slew speed to 6 (press Number key 6) or higher and use the Arrow keys to center the alignment star in the viewfinder. If your viewfinder has been aligned with the telescope, the alignment star should now be in the eyepiece. Set the slew speed to 4 or less and center the star in the eyepiece.

Go To Saturn

After performing the Easy Alignment procedure, the motor drive begins operating and the telescope is aligned for a night of viewing. Objects in the eyepiece should maintain their position even though the Earth is rotating beneath the stars.

Important Note: Once aligned, only use the GO TO or Arrow keys to move the telescope. Do not move the telescope manually, or alignment will be lost.

Once the telescope is aligned, you may choose and “Go To” any object listed in AudioStar’s Object menu. This exercise demonstrates how to select one such celestial object, the planet Saturn, for viewing from the Object menu.

Note: Saturn is not visible the entire year and you may need to choose another object from AudioStar’s database; however, the procedure, as described below, remains the same.

- 1 After the telescope is aligned, “Select Item: Object” displays. Press ENTER.
2. “Object: Solar System” displays. Press ENTER.
3. “Solar System: Mercury” displays. Keep pressing the Scroll Down key until “Solar System: Saturn” displays.
4. Press ENTER. “Calculating” displays. Then “Saturn” and a set of coordinates displays. Note that Saturn’s (and other planets’) coordinates change throughout the year.
5. Press GO TO. “Saturn: Slewing...” displays and the telescope slews until it finds Saturn. You may need to use the Arrow keys to center Saturn precisely in the eyepiece. AudioStar then automatically moves the telescope so that it “tracks” Saturn (or whatever other object you may have chosen); i.e., Saturn remains centered in the eyepiece.

After you Go To Saturn, practice the Go To feature with other objects in the Object menu lists. For example, during Winter, choose M42, the Orion nebula, from the Messier list. Or in the summer, choose the Dumbbell nebula from the Deep Sky, Named Objects list.

Using the Guided Tour

This example demonstrates using “Tonight’s Best” Guided Tour.

1. After observing Saturn, press mode twice so that “Select Item: Object” displays again.
2. Press the Scroll Down key twice. “Select Item: Guided Tour” displays.
3. Press ENTER. “Guided Tour: Tonight’s Best” displays. Press ENTER.

If you wish to try out other Guided Tours, press the Scroll Down key to scroll through other tour choices. When the tour you wish to select displays, press ENTER.

4. “Tonight’s Best: Searching...” displays. After calculating, “Tonight’s Best: Jupiter” displays.

Note: Different objects may be displayed on a tour list on any given night.

Press ENTER to display information about the object. Press GO TO to move the telescope to the object.

5. Press MODE to return to the Tour list. Press the Scroll keys to scroll through the list. Press ENTER when you find the next object you wish to observe.
6. Press and hold down MODE for two seconds to leave the Guided Tour menu.

LX65 KEY FEATURES



- 1** Diagonal Holder
- 2** Diagonal Mirror
- 3** Visual Back Thumbscrew
- 4** Visual Back
- 5** Eyepiece
- 6** Focus Knob
- 7** Red Dot Finder
- 8** Computer Control Panel

- 9** Single Fork Arm Mount
- 10** Dovetail Saddle for Optional Second Optical Tube
- 11** AudioStar Handbox
- 12** Optical Tube Assembly
- 13** Battery Compartment
- 14** Dust Cover (not visible)
- 15** Handbox Storage Cradle

LX65 Dovetail Saddle for Optional Second Optical Tube

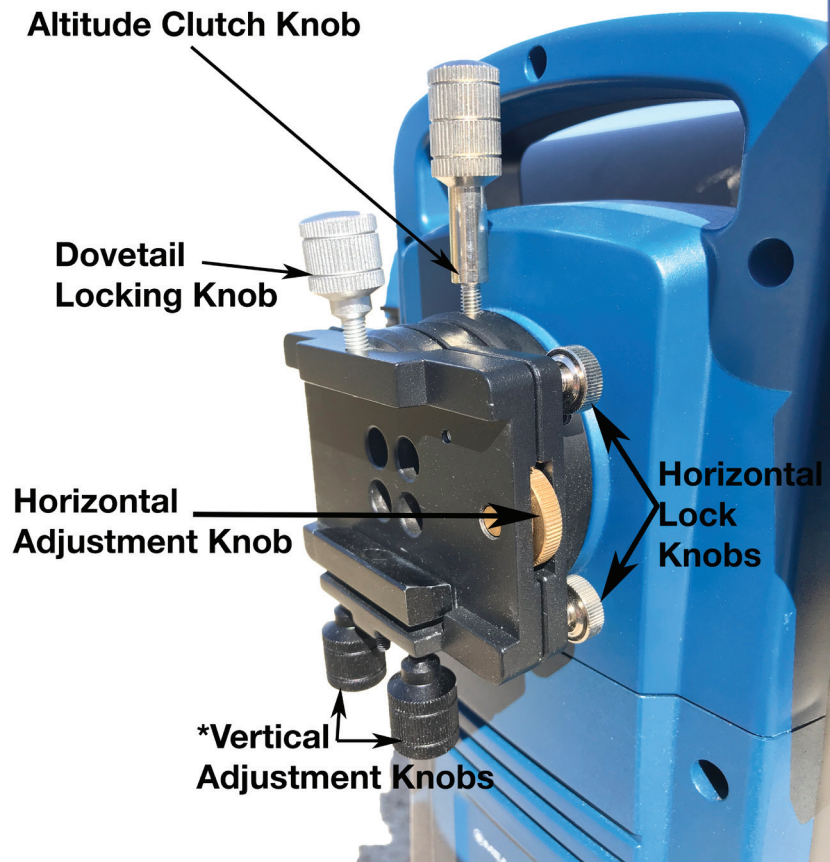

***NOTE ON USING THE VERTICAL ADJUSTMENT KNOBS:** Always rotate adjustment knobs in the same direction, at the same time, and with the same magnitude.

Always take caution when making the vertical adjustment and to support the OTA as needed. Only small adjustment should be needed.

Computer Control Panel

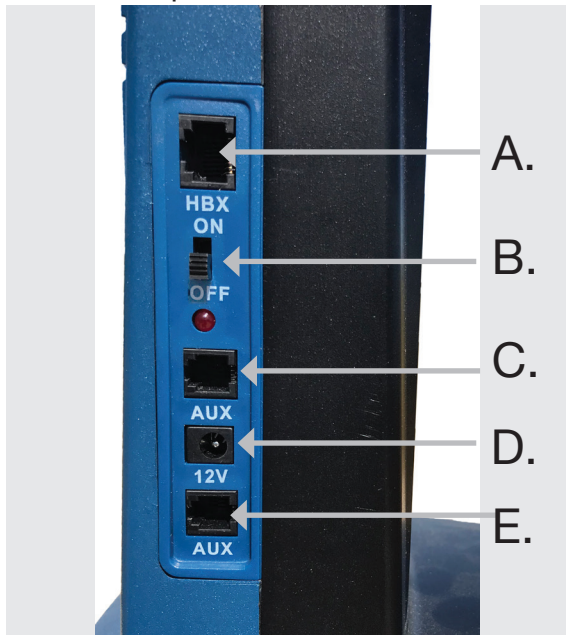

- A. Handbox (HBX) Port
- B. ON/OFF Switch with LED
- C. Auxiliary (AUX) Port
- D. 12V DC Power Input Port
- E. Auxiliary (AUX) Port

- 1 Diagonal Holder: Holds the eyepiece in place.
- 2 Diagonal Mirror: provides a more comfortable right angle viewing position. Slide the diagonal mirror directly into the eyepiece holder .
- 3 Visual Back Thumbscrew: Tighten screw to securely hold diagonal mirror, eyepiece, or accessories in place.
- 4 Visual Back: Insert the diagonal mirror here and tighten with adjacent thumbscrew to securely hold in place.
- 5 Eyepiece: Place the Super Plössl 26mm eyepiece into the 90° diagonal mirror and tighten in place with the thumbscrews. The eyepiece magnifies the image collected in the optical tube.
- 6 Focus Knob: Moves the telescope's primary mirror in a finely-controlled motion to achieve precise image focus. The LX65 telescope can be focused on objects from a distance of about 25 ft. to infinity. Rotate the focus knob counterclockwise to focus on distant objects, and clockwise to focus on nearby objects.
- 7 Red Dot Finder: Provides an easy way to sight on objects and put them in the telescope's eyepiece.
- 8 Computer Control Panel
 - A. Handbox (HBX) Port: Plug the AudioStar coil cord into this port.
 - B. ON/OFF Switch with LED: Turns the telescope power on and off. The red power indicator light illuminates when power is applied to the telescope.
 - C. Auxiliary (AUX) Port: Provides connection for Meade accessories and future enhancements.
 - D. 12V DC Power Input Port: Provides connection so that the telescope may be powered from either a 12V DC auto cigarette light plug or from an optional AC power adapter available from Meade.
 - E. Auxiliary (AUX) Port: Provides connection for Meade accessories and future enhancements.
- 9 Single Fork Arm Mount: Holds the optical tube(s) in place and moves it to find and track objects.
- 10 Dovetail Saddle for Optional Second Optical Tube: Can optionally hold an additional optical tube weighing up to 7 lbs in tandem with the main telescope optical tube.
- 11 AudioStar Handbox: Plugs into the HBX port. Provides computerized control for the LX65 including a comprehensive celestial object database, audio tours, and several other telescope functions.
- 12 Optical Tube Assembly: The main optical component that gathers the light from distant objects and brings this light to a focus for examination through the eyepiece.
- 13 Battery Compartment: Insert eight ANSI 14A (IEC LR14) Alkaline "C-Cell" (user-supplied) batteries in compartment. Be sure batteries are aligned correctly as shown in the battery compartment.
- 14 Dust Cover: Protects the optical tube assembly optics and minimizes dust accumulation during storage. Always keep the dust cover on the optical tube when the telescope is not in use.
- 15 Handbox Storage Cradle: Holds the AudioStar handbox in a conventional position on the telescope.

Choosing Eyepieces

A telescope's eyepiece magnifies the image formed by the telescope's main optics. Each eyepiece has a focal length, expressed in millimeters, or "mm." The smaller the focal length, the higher the magnification. For example, an eyepiece with a focal length of 9mm has a higher magnification than an eyepiece with a focal length of 26mm. Experienced users know that higher powers are, in general, not as useful as lower powers. Many of the objects in the night sky are relatively large and faint and look best at low magnifications.

The power or magnification of a telescope is determined by the focal length of the telescope and the focal length of the eyepiece being used. To calculate magnification, divide the telescope's focal length by the eyepiece's focal length. For example, a 26mm eyepiece is supplied with the LX65 telescope.

The focal length of the 6" ACF optical tube is 1524mm (see SPECIFICATIONS, page 47).

Telescope Focal Length 1524mm

Eyepiece Focal Length 26mm

$$1524 \div 26 = 58.6x$$

The magnification is therefore 58.6x.

Low power eyepieces offer a wider field of view, bright, high-contrast images, and long eye relief. To find an object with a telescope, always start with a lower power eyepiece such as the Super Plössl 26mm or longer focal length. When the object is located and centered in the eyepiece, you may wish to switch to a higher power eyepiece to enlarge the image as much as practical for prevailing seeing conditions or, for many objects, the view is best with a high quality low-power wide-field eyepiece.

NOTE: Seeing conditions vary widely from night-to-night and site-to-site. Turbulence in the air, even on an apparently clear night, can distort images. If an image appears fuzzy and ill-defined, reduce to a lower power eyepiece.

Your telescope comes supplied with a Super Plössl 26mm eyepiece, which gives a fairly wide field of view. This is a very good all purpose eyepiece for your telescope, but you should consider buying additional eyepieces in longer and shorter focal lengths to fully realize the potential of the optical system in your LX65 telescope.

The Series 4000 Super Plössl Eyepieces are excellent

well corrected 4 element optics at popular prices. They come in a wide range of focal lengths to give you the right magnification for any type of celestial object you are viewing. You can also use one of the Series 4000 Barlows to double or triple the magnification of a Super Plössl eyepiece. These eyepieces have been the standard for decades.

The AudioStar Handbox

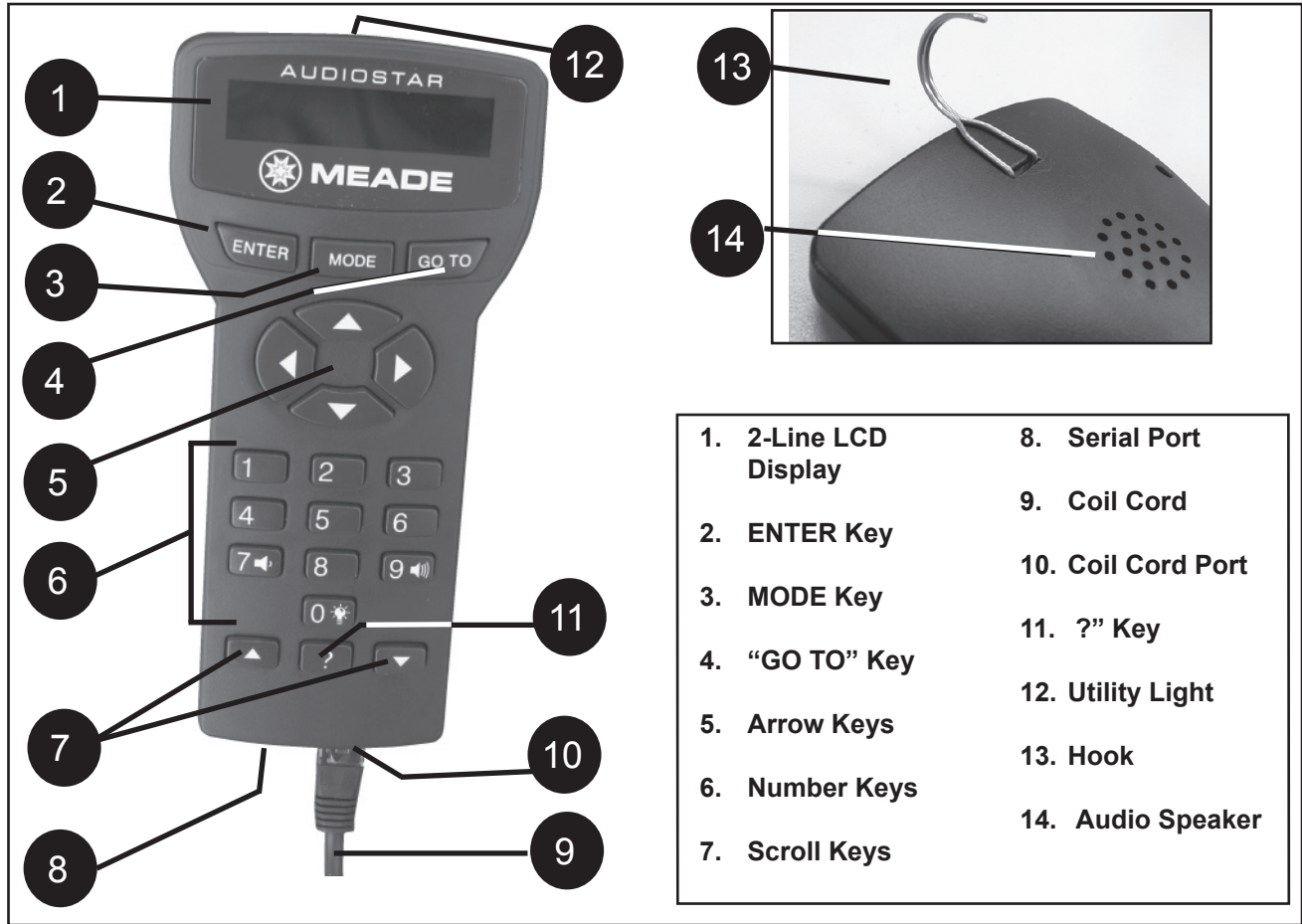

- | | |
|-----------------------|--------------------|
| 1. 2-Line LCD Display | 8. Serial Port |
| 2. ENTER Key | 9. Coil Cord |
| 3. MODE Key | 10. Coil Cord Port |
| 4. "GO TO" Key | 11. "?" Key |
| 5. Arrow Keys | 12. Utility Light |
| 6. Number Keys | 13. Hook |
| 7. Scroll Keys | 14. Audio Speaker |

Tour the Cosmos with Just the Push of a Button

Control of the LX65 is through the operation of the standard-equipment AudioStar. Nearly all functions of the telescope are accomplished with just a few pushes of AudioStar's buttons. Some of the major features of AudioStar are:

- Automatically move the telescope to any of over 30,000 objects stored in the database or manually enter the astronomical coordinates of any celestial object.
- Take a guided tour of the best celestial objects to view on any given night of the year.
- Meade's Astronomer Inside audio content. Listen through its built-in speaker as it tells you fun and informative descriptions of over 500 night sky objects as you actually view them in the eyepiece.
- Download the latest software revisions using the Meade AutoStar Updater software and share software with other AudioStar enthusiasts.
- Control your LX65 with your PC using a serial

interface.

- Access a glossary of astronomical terms.
- Calculate which eyepiece to use for optimum viewing of a celestial object.
- Mount the telescope in the "Alt/Az" mode (Altitude - Azimuth, or vertical - horizontal) for fully automatic tracking of celestial objects.

- The AudioStar Computer Controller provides control of virtually every telescope function within a compact handbox. AudioStar has soft-touch keys designed to have a positive feel. The LCD (Liquid Crystal Display) is backlit with a red LED (Light Emitting Diode) for easy viewing in the dark. The backlit display, key arrangement, and sequential database make AudioStar extremely user friendly.

1 2-Line LCD Display: Provides an interface between AudioStar and the telescope.

- Top line: Lists the primary category or menu item.
- Bottom line: Contains a menu option or information about an object or subject, depending on which function is being performed.

2 ENTER Key: Accesses, in a sequential manner, the next menu or data level in the AudioStar database. See MOVING THROUGH AudioStar’S MENUS, page 10.

NOTE: If ENTER is pressed for two seconds or more and then released, AudioStar emits a beep and “ENTER to Sync” is displayed. “ENTER to Sync” is relevant only after the telescope has been aligned and is pointing at an object. If the “ENTER to Sync” feature is accessed by mistake, press MODE to return to the previous screen. See High Precision, page 27, for more details about this feature.

3 MODE Key: Returns to the previous menu or data level in the AudioStar database until the top level, “Select Item” is reached. The MODE key is similar to the ESCAPE key on a computer.

Note: Pressing MODE while in the “Select Item” level moves AudioStar to the topmost screen: “Select Item: Object”.

If MODE is pressed and held for two seconds or more, information about the telescope’s status displays. When the status displays, press one of the Scroll keys to display the following information:

- Right Ascension and Declination (astronomical) coordinates
- Altitude (vertical) and Azimuth (horizontal) coordinates
- Date
- Site coordinates
- Local Time and Local Sidereal Time (LST)

- Timer and Alarm Status
- Battery status

Press MODE again to return to the previous menu.

4 GO TO Key: Slews (moves) the telescope to the coordinates of the currently selected object. While the telescope is slewing, the operation may be aborted at any time by pressing any key except GO TO. Pressing GO TO again resumes the slew to the object.

5 Arrow Keys: Slew the telescope in a specific direction (up, down, left, and right), at any one of nine different speeds. Speed selection is explained in “SLEW SPEEDS”, below. The following functions are also available with the Arrow keys:

- Moves the telescope – Use the Up and Down Arrow keys to move the telescope vertically up and down. The Left Arrow key rotates the telescope horizontally counterclockwise, while the Right Arrow key rotates it clockwise.
- Data entry – When the scope is prompting for user entered data, use the Up and Down Arrow keys to scroll through the letters of the alphabet and numerical digits. The Down Arrow key starts with the letter “A” and the Up Arrow key starts with the digit “9.” The Left and Right Arrow keys are used to move the blinking cursor left and right across the LCD display.

6 Number Keys: Input digits 0 - 9 and changes the slew speeds (see Slew Speeds, see below). The “0” key also turns on and off the red utility light on the top of the handbox.

Slew Speeds

LX65 has nine slew speeds that are directly proportional to the sidereal rate (the rate at which stars appear to drift across the sky) and have been calculated to accomplish specific functions. Pressing a Number key changes the slew speed, which is shown for about two seconds on AudioStar’s display.

To change the speed, press the appropriate key shown below.

Nine available speeds are:

Number Key "1" = 1x (Guide)

Number Key "2" = 2x

Number Key "3" = 8x

Number Key "4" = 16x

Number Key "5" = 64x

Number Key "6" = 0.50°/sec

Number Key "7" = 1.0°/sec

Number Key "8" = 1.5°/sec

Number Key "9" = 4.0°/sec (Max)

Speeds "1", "2", or "3": Best used for fine centering of an object in the field of view of a higher power eyepiece, such as a 12mm or a 9mm eyepiece.

Speeds "4", "5", or "6": Enables centering an object in the field of a low-to-moderate power eyepiece, such as the standard Super Plössl 26mm.

Speeds "7" or "8": Best used for rough centering of an object in the Red Dot Viewfinder.

Speed "9": Moves the telescope quickly from one point in the sky to another.

- 7 Scroll Keys: Accesses options within a selected menu. The menu is displayed on the first line of the screen. Options within the menu are displayed, one at a time, on the second line. Press the Scroll keys to move through the options. Press and hold a Scroll key to move quickly through the options.

The Scroll keys also scroll through the letters of the alphabet and numerical digits.

Note: The Scroll Down key and the Down Arrow key move forward through the alphabet & digits (A to Z, 0 to 9). The Scroll Up key and the Up Arrow key move backward (Z to A, 9 to 0). Common symbols are also available in the list.

- 8 ? Key: Accesses the "Help" file. "Help" provides on-screen information on how to accomplish whatever task is currently active.

Hold down the ? key and then follow the prompts on the display to access details of AudioStar functions in the Help feature. The Help system is essentially an on-screen instruction manual.

If you have a question about an AudioStar operation, e.g., INITIALIZATION, ALIGNMENT,

etc., hold down the ? key and follow the directions that scroll on the second line of the LCD screen. When a word appears in [brackets], press ENTER to access the AudioStar Glossary. A definition or more detailed information is displayed. Press MODE to return to the scrolling AudioStar Help display.

When satisfied with the Help provided, press MODE to return to the original screen and continue with the chosen procedure.

- 9 Coil Cord Port: Plug one end of the AudioStar coil cord into this port located at the bottom of the AudioStar handbox.
- 10 Coil Cord: Plug one end of the AudioStar coil cord into the HBX port (pg 14) of the computer control panel of the telescope and the other end into the coil cord port.
- 11 Serial Port: plug an serial accessory (#505) cable into AudioStar for updating the AudioStar Firmware, connecting to a PC, or using the Meade Wi-Fi Adapter..
- 12 Utility Light: Use this built-in red light to illuminate star charts and accessories without disturbing your eye's adaptation to darkness.
- 13 Hook: Attaching the hook to the back of AudioStar allows it to be hung on many different locations on the telescope for easy access. The hand box cradle holder can also be used.
- 14 AudioStar Speaker: Your AudioStar computer controller is equipped with Astronomer Inside technology. This revolutionary technology provides object descriptions of over 500 night sky objects while you are viewing them. Object descriptions for the Moon, planets, stars, clusters, nebulae and galaxies are presented by the Astronomer Inside. Information such as temperature, size, distance and mythology are all presented in a fun and entertaining way.

Observing Using AudioStar's Arrow Keys

You may observe land and astronomical objects using AudioStar's Arrow keys to move the telescope (Refer to the AudioStar Hand Box overview on page 17 to become familiar with the key pads and their functions on the AudioStar).

1. Verify the telescope is fully assembled and that AudioStar is properly connected to your telescope. See Getting Started on pages 5-12.
2. Flip the telescope power switch to the ON position. The AudioStar screen is activated and a copyright message displays briefly, followed by a short beep. Then AudioStar takes a few moments to start up the system. "Press 0 to align or Mode for Menu" displays (if you select "0", Alignment will begin).
3. The Arrow keys are now activated. Press the Arrow keys to slew (move) the telescope up, down, right, or left.
4. Press a Number key to change the telescope's slew speed. See Slew Speeds, on pg 18 for more information.
5. Use the Red Dot Finder (page 8) to locate an object and practice using the AudioStar's Arrow keys to center the object in the telescope's field of view.
6. Use the telescope's focus knob to bring the object into focus.

Playing the Audio

The LX65 telescope is equipped with Astronomer Inside technology. This technology provides object descriptions of night sky objects while you are viewing them. Object descriptions for the Moon, planets, stars, clusters, nebulae and galaxies are presented by Astronomer Inside. Information such as temperature, size, distance and mythology are presented in a fun and entertaining way.

To activate Astronomer Inside technology a night sky object needs to be selected. To select an object, go to the Object menu.

Once an object is selected on the AudioStar, an audio presentation for that object will begin to play. While

the audio is playing, the volume can be adjusted by pressing the 7 (volume down) or 9 (volume up) keys. To skip the current audio file and play the next, press the ? key. If there are no other audio files for that object, the audio will stop playing. If multiple audio files are available, keep pressing the "?" key to skip the audio until it stops.

LX65 TIPS

Observing Considerations

- Try to pick an observing site away from street and house lights and car headlights. While this is not always possible, the darker the site, the better.
- Try not to use a standard flashlight. Experienced observers use red LED flashlights, the red utility light on the AudioStar handbox, or tape red cellophane over their flashlights to use for setup and map reading so they don't have to continually readjust their eyes to the darkness. Be careful not to shine bright lights if there are other observers in the area. Do not shine a flashlight into the telescope while someone is observing!
- Dress warmly. It gets chilly when you're sitting for prolonged periods.
- Practice setting up your equipment during the day or in a lighted area to become familiar with it before going to a dark site.
- Use your 26mm eyepiece to view terrestrial objects and wider areas of space, such as open star clusters. Use optional higher power eyepieces, such as a 9mm eyepiece, when you wish to view something up close, such as craters on the Moon or the rings of Saturn.

AudioStar Operation

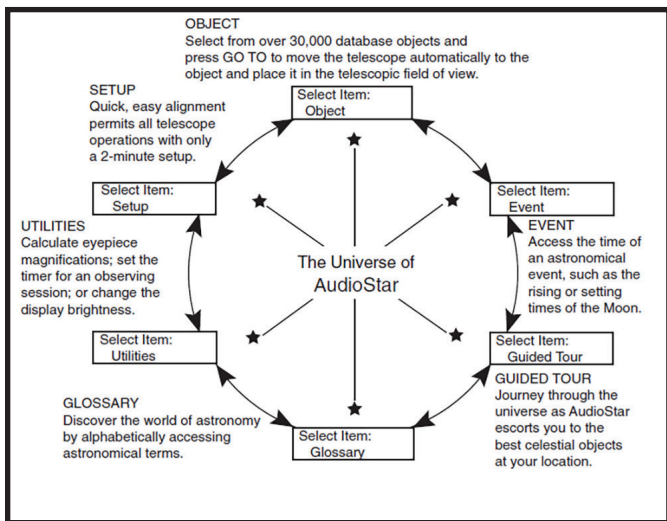

The AudioStar Universe: The six primary categories listed in the Select Item menu of AudioStar.

It is important to understand that menu selections are set in a loop. This means that pressing the Scroll Down key cycles down through all the available options within a given category, then returns to the first option. The Scroll Up key cycles up through the options in the opposite order. Note that this capability is a quick way to get to an option that is near the bottom of the list. The following example demonstrates this capability.

Example:

To navigate to the “Select Item: Setup” menu option when the “Select Item: Object” menu is displayed:

1. Press the Scroll Down key four times or the Scroll Up key once.

The screen displays two lines of information. The top line shows the current menu level. The second line displays an option which may be selected within that menu level. Some options are choices that select the next menu level down. The Scroll keys move up and down within the list of available options, showing one option at a time.

When the desired option is displayed on the second line, press the ENTER key to choose that option and move down one menu level.

Press the MODE key to leave a level; e.g., the wrong menu option is chosen.

Important Note: No matter how many levels into AudioStar are traveled, each press of the MODE key moves up a level, until the top level, “Select Item”, is reached. Once in the Select Item level, press MODE to return to the topmost level, “Select Item: Object”.

AudioStar Navigation Exercise

To demonstrate how the AudioStar menu structure works, the following exercise calculates Sunset time so an evening observing session can be planned.

To Calculate Sunset time:

1. Press the MODE key several times, until “Select Item: Object” is displayed.
2. Press the Scroll Down key once to display the “Event” option in the “Select Item” menu.
3. Press the ENTER key to choose the “Event” option and move down a level. “Event: Sunrise” is displayed.
4. Press the Scroll Down key once to display the “Sunset” option in the Event menu.
5. Press the ENTER key to choose the “Sunset” option and move down another level.
6. AudioStar calculates the Sunset time based on the current date, time, and location. AudioStar then displays the results of the calculation.
7. Press MODE once to start moving back up through the AudioStar levels. The first level up is the Event menu.
8. Press MODE again to move up another level. This is the top level, “Select Item”.
9. Press MODE again to return to the starting point of “Select Item: Object”.

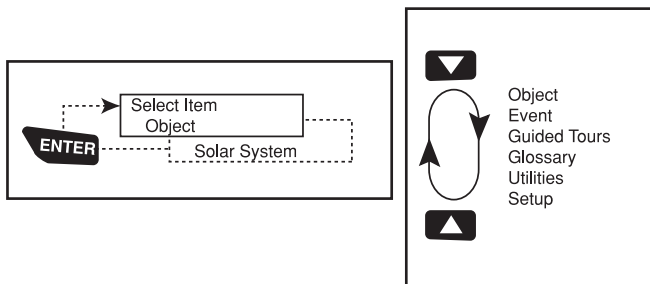

Entering Data into AudioStar

- To enter numbers and text:
 - a) Use the Number keys, or
 - b) Use the Arrow keys to scroll through numbers 0 - 9 and the alphabet. The Down Arrow key begins with the letter "A"; the Up Arrow key begins with digit "9".
- To move the cursor across the display: Use the Right or Left Arrow key to move the cursor from one number to the next in the display
- Press ENTER when the desired information has been entered.

Navigating AudioStar

AudioStar's menus are organized for quick and easy navigation:

- Press ENTER to go deeper into AudioStar's menu levels.
- Press MODE to move back toward the top menu level.
- Press the Scroll keys to move up and down through the options or lists.
- Press the Arrow keys to move the cursor across the display.
- Press the Help (?) key to access on-line help.

When multiple choices are available within a menu option, the option that is currently selected is usually displayed first and highlighted by a right pointing arrow (>).

Guided Tour Menu

When Guided Tours is selected, LX65 shows you a list of theme tours that will help you explore the night sky. These tours are pre programmed presentations of objects that are visible for the user's particular location, time and date.

The most popular tour is "Tonight's Best" that guides the user to the best objects that are currently up in the night sky. This tour is the easiest way to get started exploring the cosmos with your new LX65 telescope.

Each tour will select the objects, present information about the object and, if you press "GoTo", put that object in the eyepiece of the telescope for you to view.

The telescope comes pre-loaded with:

- "Tonight's Best", a selection of the most interesting objects visible on any night.
- "A Star's Life", tours how stars are formed, created, changes through their lives and finally die using examples that are visible tonight.
- "How Far is Far", tour showing the phenomenal distances you can see with your LX65 Series.

AutoStar Suite also allows you to create your own guided tours of the skies, including your own objects and titles (for complete instructions on how to use the authoring tools please refer to the reference manual included on the AutoStar Suite DVD).

Object Menu

Almost all observing with LX65 is performed using the Object menu category. (NOTE: Exceptions include Guided Tour and Landmarks).

Many LX65 menu categories contain databases. An LX65 database is a list of objects, such as stars, planets, comets, nebulae and so forth. When one of these objects is selected from a database by pressing "ENTER" and then "GO TO", LX65 moves your telescope (when properly aligned) and points it at the selected object.

The Object Menu options include:

Solar System is a database of the eight planets (Earth is not included) in ascending orbits from the Sun, followed by the Moon, asteroids, and comets.

Constellation is a database of all 88 Northern and Southern Hemisphere constellations. When this menu option is chosen and a constellation name appears on the first line of the screen, press GO TO once to change the second line to the name of the brightest star in the constellation.

Press GO TO a second time to slew the telescope to that star. Use the Scroll keys to cycle through the list of stars in the constellation, from brightest to dimmest.

Deep Sky is a database of objects outside our Solar System such as nebulae, star clusters, galaxies, and quasars grouped in various catalogs like Messier, Caldwell and NGC.

Star is a database of stars listed in different categories such as named, double, variable, or nearby.

AudioStar MENU TREE

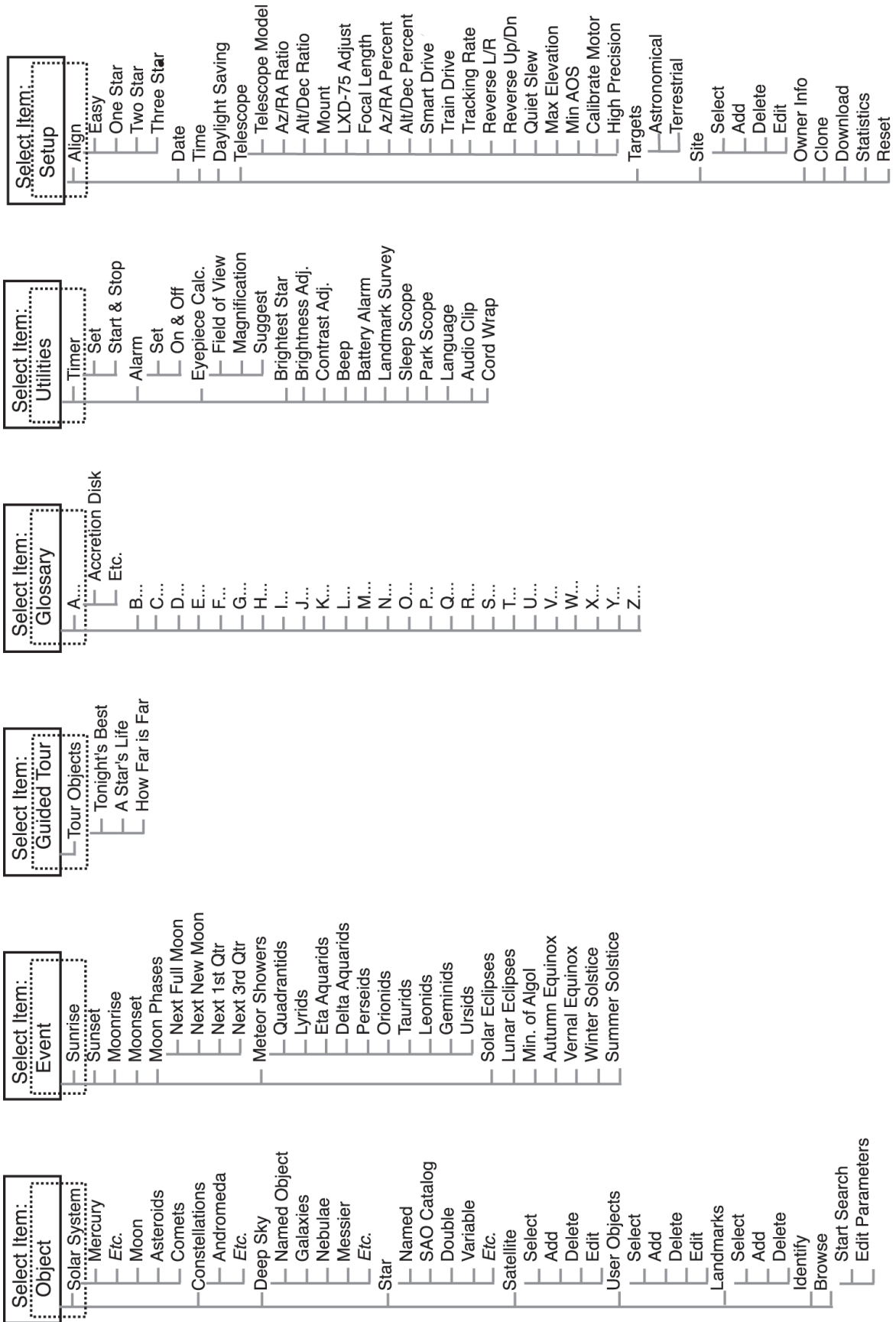

Important Note: When an object is selected, pressing “ENTER” will synchronize the telescope’s coordinates with the object. This is most useful when syncing on bright stars to achieve better pointing in the vicinity of the star.

User Objects allows the user to define and store in memory deep-sky objects of specific interest that are not currently in the LX65 database. See page 30 for more information (for complete instructions on how to use the authoring tools please refer to the reference manual included on the AudioStar Suite DVD).

Satellite is a database of Earth-orbiting objects such as the International Space Station (ISS), the Hubble Space Telescope (HST), Global Positioning System (GPS) satellites, and geosynchronous orbit satellites. In order to find and track satellites, you must download recent orbital data into the telescope.

Landmarks stores the location of terrestrial points of interest that you create in the permanent LX65 database.

IMPORTANT NOTE: To use the Landmark function, the telescope must be located and aligned exactly as when the landmark was added to the database.

- Select – To select a Landmark already in the database (see ADD below), choose the “Select” option and scroll through the list. Press “ENTER” to select a Landmark, then press “GOTO” and the telescope slews to the object.
- Add – To add a Landmark, choose the “Add” option. Enter a name for the Landmark. Locate and center the Landmark in the eyepiece, then press “ENTER”.

Identify is an exciting feature for an observer who wants to scan the night sky and start exploring. After the telescope has been properly aligned, use the AudioStar Arrow keys to move about in the sky. Then follow this procedure:

Important Note: Only use the Arrow keys to move the telescope during the Identify procedure. Do not move the telescope manually or the alignment will be lost.

1. When a desired object is visible in the eyepiece, keep pressing MODE until the “Select Item: Object” menu is displayed. Press ENTER to select this menu.

2. Scroll through the Object menu options until the “Object: Identify” screen appears.

3. Press ENTER. AudioStar searches the database for the identity of the object being observed.

4. If the telescope is not directly on an AudioStar database object, the nearest database object is located and displayed on the screen. Press GO TO and the telescope slews to that object.

Browse allows you to search the database for objects with certain parameters, much like a search engine. “Edit Parameters” lets you set various parameters for the search, such as: Object Type, Minimum Elevation, Largest, etc. Once you have set the parameters of the search, select “Start Search” and press ENTER. AudioStar will display the results of the search.

Event Menu

The Event menu provides access to dates and times of astronomical events. The Event database includes:

Sunrise and Sunset calculates the time that the Sun rises or sets on the current date.

Moonrise and Moonset calculates the time that the Moon rises or sets on the current date.

Moon Phases displays the date and time of the next New, 1st Quarter, Full and 3rd Quarter Moon.

Meteor Showers provides information on upcoming meteor showers, such as the Perseids, the Leonids, etc. Also lists the dates of the showers and when they reach maximum.

NOTE: Meteors are fast moving objects that cover large areas of the sky and are usually best observed with the naked eye.

Solar Eclipse lists upcoming Solar Eclipses, including the date and type (total, annular, or partial) of eclipse, and the location and time of the first and last contacts of the Moon’s shadow. Use the Scroll Up and Down keys to display the available data. **Remember, never use a telescope to look at the Sun!**

Lunar Eclipse lists upcoming Lunar Eclipses, including the date and type (total, partial, penumbral) of eclipse. Use the Scroll Up and Down keys to display the available data.

Min. (Minimum) of Algol is the minimum brightness of the dramatic eclipsing binary star system, Algol. It is relatively close at a distance of 100 light years. Every 2.8 days during a 10 hour period, Algol undergoes a major change in apparent magnitude as one of the two stars passes behind the other. The combined magnitude of the two stars thus dips from +2.1 to a minimum of +3.4 halfway through the eclipse as the second star is hidden. LX65 calculates minimum magnitude time at mid-eclipse.

Autumn and Vernal Equinox calculates the time and date of the fall or spring equinox of the current year.

Winter and Summer Solstice calculates the time and date of the winter or summer solstice of the current year.

Glossary Menu

The Glossary menu provides an alphabetical listing of definitions and descriptions for common astronomical terms and AudioStar functions. Access directly through the Glossary menu or through hypertext words embedded in AudioStar. A hypertext word is any word in [brackets], usually found when using the AudioStar Help function or when reading a scrolling message such as a description of a planet or star. Press ENTER whenever a hypertext word is on screen and AudioStar goes to the glossary entry for that word.

To access directly from the Glossary menu, use the Scroll keys to scroll through the alphabet. Press ENTER on the desired letter. Scroll to the desired entry and then press ENTER to read the description.

Utilities Menu

The Utilities menu provides access to several extra features within AudioStar, including a countdown timer and an alarm. The Utilities functions include:

Timer selects a countdown timer. This feature is useful for functions such as astrophotography and tracking satellites. See OBSERVING Satellites, page 30. To use the Timer, press ENTER, then choose “Set” or “Start/Stop.”

- Set: Enter the time to be counted down, in hours, minutes, and seconds, then press ENTER.
- Start/Stop: Activates the timer set previously. Use the Scroll keys to toggle between ON and OFF. When ON is displayed, press ENTER to

activate the timer. When the timer runs out, four beeps sound and the timer is deactivated.

Alarm selects a time for an alarm signal as a reminder. To use the Alarm, press ENTER, then choose “Set” or “Start/Stop”.

- Set: Enter the time of day for the alarm to sound, in hours, minutes, and seconds, then press ENTER.
- Start/Stop: Activates the alarm set previously. Use the Scroll keys to toggle between ON and OFF. When ON is displayed, press ENTER to activate the alarm. When the alarm time arrives, AudioStar beeps. Press ENTER to deactivate the alarm.

Eyepiece Calc calculates information about an eyepiece for the specific telescope to which AudioStar is connected.

- Field of View: Scroll through a list of available eyepieces. When an eyepiece is selected, the field of view is calculated.
- Magnification: Scroll through a list of available eyepieces. When an eyepiece is selected, the magnification is calculated.
- Suggest: AudioStar calculates and suggests the best eyepiece for viewing, based on the telescope and the object being viewed.

Brightness Adj adjusts the brightness of the display using the Scroll keys. When complete, press ENTER.

Contrast Adj adjusts the contrast of the display using the Scroll keys. When complete, press ENTER.

Note: This feature is usually only required in very cold weather.

Landmark Survey automatically slews the telescope to all user-defined landmarks with a short pause at each location. Press ENTER to start the survey. While a slew is in progress, press any key to skip that object and go to the next landmark on the list. To observe a landmark for a longer period, press MODE when paused on the object to stop the survey. Press ENTER to restart the survey at the first object on the list. See Landmarks, page 34.

Sleep Scope is a power saving option that shuts down

AudioStar and the telescope without forgetting its alignment. With “Sleep Scope” selected, press ENTER to activate the Sleep function. AudioStar goes dark, but the internal clock keeps running. Press any key, except ENTER, to re-activate AudioStar and the telescope.

Park Scope is designed for a telescope that is not moved between observing sessions. Align the telescope one time, then use this function to park the telescope. Next time it is powered up, enter the correct date and time – no alignment is required. Pressing ENTER causes the telescope to move to its pre-determined Park position. Once parked, the screen prompts to turn off power.

Important Note: When the “Park Scope” option is chosen and the display prompts you to turn off the telescope’s power, AudioStar is unable to be returned to operation without turning the power off and then back on.

Language: Select the English language or other pre-loaded language and AudioStar will display text and audio descriptions in the selected language.

Cord Wrap, when set to “On”, moves the telescope in such a way as to prevent the cords and cables attached to your telescope assembly from getting wound around the assembly and tangled as the telescope slews to objects. “Off” is the default setting.

Audio Clip: Select from Automatic or On Demand. The Automatic setting will automatically play the object audio when a night sky object is selected on the AudioStar. The On Demand feature requires the user to press the ? key once a night sky object is selected. Pressing the ? key will then play the audio presentations for the selected object.

Setup Menu

The Setup menu’s primary function is to align the telescope. However, there are numerous other features available within the Setup menu, including:

Date changes the date used by AudioStar. Always make sure the date is correct in AudioStar before beginning. This function can also be used to check events in the past or future. For example, set the Date menu for a day three months in the future. Then check the “Select Item: Event” menu for the Sunset time on that date.

Time changes the time entered into AudioStar.

Setting the correct time is critical for AudioStar to properly calculate locations and events. Always make sure the time is correct in AudioStar before beginning. Time may be set to 24-hour mode (military time) by selecting the “blank” option which follows the “AM” and “PM” options.

Daylight Saving is used to enable or disable Daylight Savings time.

Note: Daylight Savings Time may be referred to by different names in various areas of the world. Check local time to verify.

Telescope accesses the several options, including:

- **Model:** Allows you to select the telescope model connected to AudioStar.
- **Focal Length:** Displays the focal length of the selected telescope.
- **Az Ratio and Alt Ratio:** The Az (Azimuth) ratio and Alt (Altitude) ratio refers to the gears of the telescope’s motors. Do not alter these numbers.
- **Az Percent:** The Az (Azimuth) Percent allows you to change the azimuth backlash, i.e., the way the Arrow keys move the telescope along the azimuth (horizontal) axis. If you enter a value near 100, the telescope tube responds more quickly (it responds immediately at 100%) as you hold down an Arrow key and also slews (moves) the tube more quickly. If you enter a value near 0, it takes longer for the tube to respond as you hold down an Arrow key and also slews the tube more slowly. Experiment with this option. Try changing the percent value until you get a “feel” for the Arrow keys that is comfortable for you.
- **Alt Percent:** The Alt (Altitude) Percent operates identical to the Az Percent option (see above), but allows you to change the altitude backlash, i.e., the way the Arrow keys move the telescope when moving along the altitude (vertical) axis.
- **Train Drive:** Trains the Altitude and Azimuth motors to locate objects with more precision.

If you are experiencing any problems with pointing accuracy, follow the procedure described in APPENDIX A: TRAINING THE DRIVE, page 42, to insure accurate pointing and tracking.

- **Tracking Rate:** Changes the speed at which the telescope tracks targets in the sky.
- a. **Sidereal:** The default setting for AudioStar; sidereal rate is the standard rate at which stars move from East to West across the sky due to the rotation of the Earth.
- b. **Lunar:** Choose this option to properly track the Moon over long observing sessions.
- c. **Custom:** Allows entry of user-defined tracking rates.
- **Reverse L/R** reverses the functions of the Left and Right Arrow keys (i.e., the Right key moves the telescope to the left).
- **Reverse UP/DOWN** reverses the functions of the Up and Down Arrow keys (i.e., the Up key moves the telescope down).
- **Quiet Slew** sets the maximum slew rate to 1.5° for quieter operation.
- **Max Elevation** allows you to enter a value in degrees that sets a limit as to how far the optical tube can swing upward during a programmed slew. (Note that it does not prevent you from performing a manual slew past this limit.) This is useful when you have a camera or other peripheral attached to the telescope—you can prevent it from striking the telescope base.
- **Min AOS** (Acquisition of Signal) allows you enter a value in degrees. This value represents the altitude at which your telescope begins to slew when acquiring a satellite track. This is useful when you are observing satellites, but a tall tree or building is obstructing the telescope. For example, you might begin to track the satellite at 15° altitude, instead of 5°. See Observing Satellites, page 30, for more information about satellites.
- **Calibrate Motor** if the telescope motors appear to have a problem, use this option to retest the motors before performing a Reset. This option is also used if an AudioStar unit is moved between telescopes, to match AudioStar to the new telescope. To calibrate the motors, select this option and press ENTER.
- **High Precision** if turned on, when looking for a faint celestial object (i.e., a nebula or galaxy), AudioStar first slews to a nearby bright star and displays “ENTER to Sync”. Center the star in the

eyepiece, then press ENTER. At that point the telescope has a high precision alignment to that part of the sky and it then slews to the object that was originally requested.

Targets switches between Astronomical targets and Terrestrial targets. If “Astronomical” is selected, the telescope tracking motor is activated and any object you observe will remain centered in the eyepiece. If “Terrestrial” is selected, the tracking motor is turned off..

Site provides access to several options including:

- **Select:** Displays the currently selected observing site. Use the Scroll keys to cycle through all available sites (see Add below). Press ENTER when the site you wish to select displays. Use this option when you move to a different geographic location.
- **Add:** Allows you to add new observing sites to the database (up to six sites may be stored). Scroll through the list of Countries/States. Press ENTER when the site you wish to add displays. Then choose the desired city in the same manner.
- **Delete:** Deletes a stored site from the database.
- **Edit:** Edits a selected site, including: the name, latitude, longitude, and time zone. Time Zone refers to the Greenwich Mean Time (GMT) time zone shift. Users West of Greenwich, England use “-” hours, East of Greenwich use “+” hours. For the United States, look up the time zone shift in the table at left.

AudioStar compensates for daylight savings time, if selected.

Owner Info accesses the owner information menu, including:

- **Name:** Users may enter both their first and last names using the Up and Down Arrow keys to cycle through the alphabet. Use the Right and

Left Arrow keys to move through the text. Press ENTER when the entry is complete.

- **Address:** Use the Up and Down Arrow keys to enter your street address, city, state, and zip code. Press ENTER when the entry is complete.

Download transfers information from another AudioStar during cloning (see below). During the operation, the warning “Downloading Do Not Turn Off” appears.

Note: The Download function requires the optional #505 Astrofinder Software and Cable Connector Kit. See the instruction sheet included with the kit for more information on how to download.

Clone uploads information from one AudioStar handbox to another. Three options are available:

- **Catalogs:** Sends only user-defined object information, such as new satellite orbits or comet data to another AudioStar handbox.
- **Software:** Sends only the basic AudioStar software. This is useful if one user has downloaded a new version of AudioStar software from the Meade website (www.meade.com) and wants to pass this software along to friends.
- **All:** Everything – user-defined information and AudioStar software – is sent to another AudioStar.

Statistics provides basic statistical data about AudioStar, including:

- **Characters Free:** Shows how much room is available in user-defined object memory.
- **Version:** Shows the current version of the AudioStar software.

Reset completely resets AudioStar. Most values entered into the menus revert to factory defaults.

Advanced AudioStar Features

Adding Observing Sites

If you plan to observe using AudioStar at different geographic locations, you can store up to six observation sites in AudioStar's memory to help simplify your telescope setup. Perform these procedures using the Site options (Add, Select, Delete, Edit) of the Setup menu.

To Add a Site to the user-defined site list:

In this example, you will choose a city and add it to the database list. You will then select the site to enable it.

1. Navigate to the "Setup: Site" menu. Press ENTER,
2. Scroll through the options until "Site: Add" displays. Press ENTER.
3. You are given a choice to enter a zip code (press "1") or select a city from the list (press "2"). If you choose "Zip", enter the digits of your zip code and press ENTER.
4. If you choose "City", scroll through the list of countries/states. Press ENTER when the country/state you wish to add displays.
5. Scroll through the list of cities. Press ENTER when the city you wish to select displays. The sites you choose will appear at the top of the Select list (all other available sites will be listed after the sites you have chosen).
6. To choose a site, navigate to "Site: Select". Press ENTER. Scroll through the list of sites. Both Zip Codes and Cities are displayed. When the desired zip code or site displays, press ENTER.

To Edit a Site:

In this procedure, you will enter a location that is not available in the AudioStar database by editing data of a nearby site. You will edit the location's name, latitude, longitude and the time zone shift. You will then select the site to enable it.

You will need to know the latitude and longitude of your location to perform this procedure. This information is available on most maps.

1. Using the Add option, choose a site on the list that is closest to your observing site and press ENTER so that the site is added to your observing sites list. Choosing a site already on

the list (as opposed to using the "Custom" feature) makes it easier to edit, as the "Time Zone" value may not need to be changed.

2. Scroll to "Site: Edit" and press ENTER. "Edit: Name" displays. Press ENTER.
3. The name of the site you have just entered to your list displays; if it does not, scroll to the site.
4. Using the Arrow keys, change the name of the site so that it now reads the name of your observing location. Press Enter. "Edit: Name" displays again.
5. Press the Scroll Down key and "Edit: Latitude" displays. Press ENTER.
6. Using the Number Keys, enter the latitude of your observing site and then press ENTER. "Edit: Latitude" displays again.
7. Press the Scroll Down key and "Edit: Longitude" displays. Press ENTER.
8. Using the Number Keys, enter the longitude of your observing site and then press ENTER. "Edit: Longitude" displays again.
9. Press the Scroll Down key and "Edit: Time Zone" displays. Press ENTER. (If the site you chose from the list in step 1 has the same Time Zone as the site you are editing, just press ENTER again to go on to the next step.) "Time Zone" refers to the Greenwich Time Zone shift. Users West of Greenwich, use "-" hours (one hour per time zone) and users East of Greenwich use "+" hours. For the United States, look up the shift in Table 1, at the left.
10. After entering the shift, press ENTER. "Edit Time Zone" displays.
11. Press MODE. "Site: Edit" displays.
12. Using the Arrow keys, scroll to "Site: Select". The site you have just edited displays. Press ENTER to select the site or press MODE to exit.

Using AudioStar to Find Objects Not in the Database

In this procedure, you will enter coordinates of celestial objects that do not appear in any of the AudioStar database lists. You will enter the object's name and R.A. and Dec. coordinates (required information). You may also enter the object's magnitude and size (optional information).

Although AudioStar contains an extensive database of celestial objects (stars, nebulae, planets, etc.) that you can observe, you may eventually want to view objects that are not part of the database. AudioStar provides a feature that allows you to enter an object's R.A. and Dec. coordinates in the "User: Objects" option of the Object menu and allows automatic slewing of the telescope to the user-entered coordinates.

In order to use this menu option, you first need to look up the R.A. and Dec. coordinates of the object or objects you wish to observe. Check out your local library, computer store, or bookstore for astronomy books, CD ROMs, or magazines (such as Sky & Telescope or Astronomy), to find coordinates of celestial objects. The objects/coordinates you enter become part of your own permanent database, called "User Objects".

To enter coordinates of an object into the "User: Objects" option of the Object menu:

1. Make sure AudioStar has been initialized and the telescope has been aligned.
2. After the telescope is aligned, "Select Item: Object" displays. (If necessary, use the Scroll keys to scroll through the menus, as previously described, to find this option.) Press ENTER.
3. "Object: Solar System" displays. Keep pressing the Scroll Up key until "Object: User Object" displays and press ENTER.
4. "User Object: Select" displays. Press the Scroll Down key once. "User Object: Add" displays. Press ENTER.
5. "Name" displays on the top line and a blinking cursor on the second line. Use the Arrow keys, as previously described, to enter the name of the object you wish to add to the database. When you are finished, press ENTER.
6. "Right Asc.: 00.00.0" displays. Use the Number keys to enter the digits for the Right Ascension coordinate of your object. When you are finished, press ENTER.

7. "Declination: +00°.00'" displays. Use the Number keys to enter the digits for the Declination coordinate of your object. If necessary, use the Scroll Keys to change "+" to "-". When you are finished, press ENTER.
8. AudioStar then prompts you to enter the size of the object. This step is optional. Use the Number keys to enter the size (in arc-minutes), if so desired, and press ENTER to go to the next display. If you do not wish to enter this information, simply press ENTER.
9. AudioStar then prompts you to enter the magnitude of the object. This step is also optional. Use the Number keys to enter this information, if so desired, and press ENTER to go to the next display. "User Object: Add" displays again.

To GO TO a user-entered object:

In this procedure, you will choose an object from the User Object list and GO TO the object.

1. With "User Object: Add" displayed, press the Scroll Up key once. "User Object: Select" displays. Press ENTER.
2. Use the Scroll keys (if necessary) to scroll to the desired object. Press ENTER.
3. The name of the object and the Right Ascension and Declination coordinates display.
4. Press GO TO and the telescope slews to the object.

Observing Satellites

In this procedure, you will prepare your telescope to observe a satellite pass.

1. Navigate to the "Object: Satellite" menu option and press ENTER.
2. Use the Scroll keys to scroll through the list of satellites.
3. Select a satellite from list and press ENTER.

4. “Calculating...” and then “Tracking...” displays. If the satellite is going to make a pass, “Located” displays.
5. Use the Scroll keys to display data about the pass: aos—acquisition of signal and los—loss of signal. If you subtract the aos from the los, you can calculate how long the satellite will be visible. Location information also displays.
6. “Alarm” displays after the location information. Press ENTER and AudioStar automatically sets the alarm to sound a minute before the satellite’s scheduled appearance. You may return to regular observations until the alarm goes off.
7. When the alarm goes off, return to the Satellite menu and press a Scroll key until the desired satellite is on the top line of the display.
8. Press GO TO. AudioStar slews the telescope to where the satellite should appear. The motor drive stops and a countdown is displayed.

Note: If the scheduled appearance position of the satellite is obstructed (i.e., by a building, tree, or hill), press ENTER and AudioStar starts to move the telescope along the expected satellite track. When the track clears the obstruction, press ENTER again to pause the telescope, then continue with this procedure.
9. With about 20 seconds left on the countdown timer, start watching through the Red Dot Finder for the satellite to enter the field of view.
10. When the satellite enters the viewfinder field of view, press ENTER. The telescope starts to track with the satellite.
11. Use the AudioStar Arrow keys to center the object in the viewfinder, then look through the eyepiece to view the object.

Satellite orbits change and new satellites (including the Space Shuttle) are launched. Visit the Meade web site (www.meade.com) to get updated information and instructions on how to download this data to AudioStar. If orbital parameters are more than one month old, the satellite pass may not happen at the time predicted by AudioStar. Downloading requires the optional #505 AstroFinder™ Software and Cable Connector Kit.

NOTE: Satellite observing is an exciting challenge. Most satellites are in low orbit, traveling at approximately 17,500 mph. When visible, they move

quickly across the sky and are only in the field of view for a few minutes, requiring AudioStar to slew the telescope rapidly. Best viewing is near Sunrise or Sunset when the sky is still dark. Viewing in the middle of the night can be problematic because the satellite may pass overhead, but not be visible as it is in the Earth’s shadow.

How to Create Your Own Guided Tour

When a Guided Tour is selected, AudioStar slews your telescope to a predetermined list of objects and displays information about each object, such as type of object, constellation location, R.A. and Dec. coordinates, and so forth. AudioStar contains a few Guided Tours which are programmed at the factory. But it is also possible for an observer to create a custom Guided Tour.

A tour is basically an ASCII text file that contains a list of directions and descriptions. Each line of a tour is either a comment line, a command line, or a description.

What you will need:

- A PC with text editor or word processing software installed (the tour must be saved as a “text only” or as a “MS-DOS text” file).
- The Meade #505 Cable Connector Kit to download tour information to the AudioStar handbox.

Tour Modes

The objects chosen for a tour list are selected from AudioStar’s database or by entering the object’s R.A. and Dec. coordinates. The tour is presented in one of two modes:

Automatic Mode: The title of an object appears on first line and descriptive text scrolls on line 2.

Interactive Mode: Tour name appears on the first line of the AudioStar display and the name of the object displays on line 2. To display descriptive text in this mode, the user must press ENTER.

Comment Line

Information in the Tour program that is not displayed, such as authorship, revision history, copyrights, etc. All comments begin with a “/” character in column 1 of the line. For example:

```
/ Extreme Object  
/ (c) 2018 Meade Instruments Corporation
```

Command Line

This line contains programming commands, including: R.A. and DEC. coordinates, a title string, a description string, and a keyword.

R.A.: Enter the Right Ascension of an object in the following format: HH:MM:SS.

Eg., 18:51:05

Dec.: Enter the Declination of an object in the following format: DDdMMmSSs. Eg., – 06d16m00s

Title String: Text within a title string is displayed as the title of the object. A title string can contain up to 16 characters and must be surrounded by quotation marks. For example. “M64” or “My Favorite Star”.

In Interactive Mode, the title string appears on line 2 until it is selected with the ENTER key.

In Automatic Mode, or after Interactive Mode selection, the title string appears on line 1 while the description scrolls across line 2.

Keywords: Action to be performed during a tour. AudioStar recognizes the following keywords:

TITLE	TEXT
USER	NGC
IC	SAO
MESSIER	CALDWELL
PLANET	MOON
SATELLITE	ASTEROID
COMET	LUNAR ECLIPSE
METEOR SHOWER	DEEP SKY
CONSTELLATION	STAR
LANDMARK	DEFINE
PICK ONE/PICK END	AUTO SLEW ON/OFF
#END	

Description String: Description of an object. Must be surrounded by quotation marks. If the description is longer than one line, each line must end with a quotation mark and a hard return. Begin the next description line with a quotation mark.

If quotation marks are to be displayed in the on-screen description, use two quote marks at the beginning and end of the desired phrase. For example: “The Orion Nebula is considered “awesome” by many who view it”.

Writing a Tour

Using the list of commands listed above, a custom tour can be created. Placing the word AUTO SELECT before any of the command lines activates Automatic Mode and, when selected, AudioStar automatically searches and finds the designated object.

The following is a list of command lines, complete with keywords and necessary strings:

TITLE

Title must be the first keyword in your tour after any comment lines and must be 15 characters or less. AudioStar displays this title when “Guided Tour” is selected from the menus.

For example: TITLE “A Star’s Life”

TEXT “title string” “description string”

This command allows you to display a text title and description.

USER ra dec “title string” “description string”

This command line allows you to access a specific object with your own description. Enter USER, then the R.A. and DEC. of a desired object, and its title and description. Use the format described in the Command Line section.

The following commands specify objects that are already in the AudioStar database. If these commands follow the command AUTO SELECT, the object’s title displays on line 1 and its description scrolls across line 2.

Do not add a description string after the following command lines; these commands access object with existing description in the AudioStar database.

NGC xxxx

Enter NGC followed by the desired New General Catalog number and AudioStar provides the user with a description of the object from its database. For example: NGC 4256

IC xxxx

Enter IC followed by the desired Index Catalog number and AudioStar provides the user with a description of the object from its database. For example: IC 1217

SAO xxxxxx

Enter SAO followed by the desired SAO number and AudioStar provides the user with a description of the object from its database. For example: SAO 30200

Messier xxx

Enter MESSIER followed by the desired Messier number and AudioStar provides the user with a description of the object from its database. For example: M 101

CALDWELL xxx

Enter CALDWELL followed by the Caldwell number and AudioStar provides the user with a description of the object from its database. For example: CALDWELL 17

PLANET "name"

Enter PLANET and then the name of the desired planet in quotes. AudioStar provides the user with a description of the selected planet from its database. For example: PLANET "Pluto"

MOON

This command accesses information about the Moon from the AudioStar database.

SATELLITE "name"

Enter SATELLITE and then the name of the desired satellite in quotes. AudioStar displays information about the satellite from its database. For

example: SATELLITE: "Intl Space Stn"

ASTEROID "name"

Enter ASTEROID and then the name of the desired asteroid in quotes. AudioStar displays information about the asteroid from its database. For example: ASTEROID: "Ceres"

COMET "name"

Enter COMET and then the name of the desired comet in quotes. AudioStar displays information about the comet from its database. For example: COMET: "Halley"

LUNAR ECLIPSE

If LUNAR ECLIPSE is part of the tour, AudioStar checks its database every time the tour is activated to see if a lunar eclipse is visible that evening. If no eclipse is visible, this option is skipped and the tour proceeds on the next object.

METEOR SHOWER

If METEOR SHOWER is part of the tour, AudioStar checks its database every time the tour is activated to see if a meteor shower is visible that evening. If no meteor shower is visible, this option is skipped and the tour proceeds on to the next object.

DEEP SKY "name"

Enter DEEP SKY followed by the name of the desired object in quotes. For example:

DEEP SKY "Small Magellanic Cloud"

CONSTELLATION "name"

Enter CONSTELLATION followed by the name of the desired constellation in quotes. For example: CONSTELLATION "Leo Major"

STAR "name"

Enter STAR followed by the name of the desired star in quotes. For example: STAR "Vega"

LANDMARK az alt "title" "description"

Enter the azimuth (az) for the desired object in the following format: xxxdxxmxxs. For example: 123d27m00s. Then enter the altitude of the desired object in the following format: xxdxxmxxs. Then enter the title string and description string in quotes. For example:

LANDMARK 123d27m00s 57d20m20s "Landmark 1"
"North corner of apartment building"

PICK ONE / PICK END

These two statements are used to surround a list of items that AudioStar can choose from during a tour. AudioStar begins at the top of the PICK ONE list and displays the first object from the list that is above the horizon and ignores the rest.

This statement is useful for developing tours that can be presented year round. For each object type you wish to use to illustrate in your tour, pick 10 to 12 examples spaced across the range of right ascension. Bracket them by the PICK ONE / PICK END statements. One current example displays for the user. For example:

AUTO SELECT TEXT "Globular Cluster" "Globular clusters are huge balls of stars".

"They contain 50,000 to 100,000 stars and are located on the fringes of our "galaxy".

PICK ONE

AUTO SELECT MESSIER 13

AUTO SELECT MESSIER 15

AUTO SELECT MESSIER 92

AUTO SELECT MESSIER 4

AUTO SELECT MESSIER 68

AUTO SELECT NGC 1234

AUTO SELECT TEXT "None Available" "I'm sorry. There are no bright globular" "clusters visible at this time".

PICK END

AUTO SLEW ON / AUTO SLEW OFF

With AUTO SLEW ON enabled in the tour, AudioStar automatically slews the telescope to objects first before displaying the text description. This feature is useful when designing tours in which observing certain objects is required. For example, an astronomy professor may require his students to observe six objects, four of which AudioStar automatically slews to in a tour. The students would have to manually slew to the last two objects. He would then place AUTO SLEW ON before his first required object and AUTO SLEW OFF after the fourth object.

#END

To end a tour, type the command #END on a separate line at the very end of the tour.

Downloading Tours

Once a tour is written and stored as an ASCII file (saved either as a "text only" or "MS DOS text" file), load it into AudioStar using the AudioStar Update Utility on your PC. As tours are downloaded into the handbox, AudioStar examines the programming. If it doesn't understand the terminology used within a tour, it flags questionable areas and displays them in a pop-up window on your computer screen. Make the necessary corrections and try to download again. See the instruction sheet with your #505 Cable Connector Kit for more information about downloading data to and interfacing with AudioStar.

Landmarks

This menu option allows you to define and store terrestrial objects in the Landmark database. First, a landmark needs to be stored in memory using the "Landmark: Add" option. To view a landmark, use the "Landmark: Select" option. Landmarks may also be viewed using the "Landmark Survey" option in the Utilities menu.

To Add a landmark to the database:

In this procedure, you will store the location of terrestrial landmarks in AudioStar's memory.

1. Set the telescope in the home position, if necessary. Note for future reference where the telescope is located and if you have aligned the telescope, which alignment method is used.

IMPORTANT NOTE: To use the Landmark function, the telescope must be located and aligned exactly as when the landmark(s) was added to the database.

2. Display the "Setup: Targets" menu option. Choose "Terrestrial" and press ENTER – "Setup: Targets" displays again. Choosing this option turns off tracking for astronomical objects and is not useful for the viewing of terrestrial objects such as those in the Landmark database. Be sure to change this option back to "Astronomical" when you wish to view celestial objects again.
3. Press MODE once. "Select Item: Setup" displays.
4. Press the Scroll Down key once and "Select Item: Object" displays. Press Enter. "Object: Solar System" displays.
5. Press the Scroll Up key twice and "Object: Landmarks" displays. Press ENTER. "Landmark: Select" displays.
6. Press the Scroll Down key once. "Landmark: Add" displays. Press ENTER.
7. "Landmark Name" displays. Using Arrow keys, enter a name for the landmark you wish to add to the database. When finished, press ENTER.
8. "Center Landmark. Press Enter" displays. Using only the Arrow keys (do not manually move the telescope), move the telescope to the desired landmark and center the object in the eyepiece. Press Enter. The object is now stored in memory.
9. "Landmark: Add" displays. If you wish to add more landmarks, repeat steps 5 through 7.

To Select a landmark from the database:

1. Make sure the telescope is located and aligned exactly as when the desired landmark was entered into memory.
2. Display the "Landmark: Select" menu option. Press ENTER.
3. Use the Scroll keys to scroll through the list of objects you have previously entered. When the desired object displays, press ENTER to select the object. Use the Scroll keys to scroll through location information about the object, if desired. Press GO TO to slew the telescope to the landmark.
4. Press MODE to exit.

To perform a Landmark Survey

This procedure allows you to perform a tour of the objects entered in the "Object: Landmark" menu option – note that the Landmark Survey will function only if you have previously entered objects in the Landmark menu.

1. Navigate to "Utilities: Landmark Survey" menu and press ENTER.
2. "Landmark Survey: Slewing..." displays. The telescope moves to the first object on the Survey list and displays the name of the object.
3. Press MODE to pause the Survey. Press Enter to restart the survey at the first object of the survey.

To check on the available amount of memory in AudioStar.

AudioStar has a limited amount of memory. Once you begin to store Landmarks, User Objects and other bits of information in AudioStar, you will begin to use up memory. This procedure allows you to check on how much memory is still available.

1. Navigate to the "Setup: Statistics" menu option and press ENTER.
2. "Statistics: 97.4K Char. Free" displays. This is the amount of memory that is still available to the user.

Identify

This procedure allows you to use AudioStar to identify objects you have found in the night sky using the Arrow keys. If the object is not in AudioStar's database, AudioStar displays information about an object in its database that is closest to the one you queried about.

Important Note: The telescope must be successfully aligned before the Identify feature can be used. Once aligned, it cannot be physically moved from that location. Moving the telescope disrupts the telescopes frame of reference to the night sky and will prevent it from identifying objects.

In this procedure, you will center an object you wish to have identified by AudioStar in the telescope eyepiece and use the "Identify" menu to find out information about the object or the nearest object to it in the AudioStar database.

1. Center the object you wish to have identified in the telescope's eyepiece.
2. Navigate to the "Object: Identify" option and press ENTER.
3. "Searching..." displays. When AudioStar finishes calculating, the name of the closest object displays.
4. Press a Scroll key to display information about this object. AudioStar displays some or all the following information about the object with each press of a Scroll key:

Displayed information:	Example:
Catalog or common name.....	Messier 107, NGC 617 Orion Nebula, etc.
Type of object.....	Globular Cluster, Nebula, Black Hole, etc.
Right Ascension	16:32:4
Declination.....	13°03'
Constellation	Virgo, Orion, etc.
Magnitude	3
Size.....	2'
Scrolling message.....	"This Globular Cluster is 10,000 light years away..."

Advanced Alt/Az Alignment

If you would rather choose your own alignment stars from the AudioStar database during the Alt/Az alignment procedure, AudioStar offers two methods described below.

Two-Star Alt/Az Alignment

Two-Star Alignment requires some knowledge of the night sky. AudioStar provides a database of bright stars and two stars from this database are chosen by the observer for alignment.

1. Turn the telescope on: Turn the telescope power switch to the ON position. The AudioStar beeps and the display screen is activated. AudioStar then takes a few moments to start up the system.
2. Select Alignment Procedure: "Press 0 to Align or Mode for Menu" displays. Press "Mode" to access the AudioStar menu.
3. Testing Motors: The telescope then tests the motor function of the telescope by moving in the horizontal and vertical directions.
4. Set Your Location or Zip Code: The Location screen displays. This screen asks you if you wish to choose either the zip code of your observing location or the location (i.e., entering the city and state or country of your observing location). Press "1" to select the zip code option or "2" to enter the city and state.

Note: The location settings (country/state/province and city, or zip code) are only asked for the first time you turn on the control panel. If you wish to change this setting later on, use the Site menu.

- a. If you chose the zip code option, the left most "0" is highlighted. Use the Number keys to enter the digits. As you enter a digit, the next digit to the right will be highlighted. Enter the next digit. Repeat this process until all 5 digits of your zip code are entered. Press ENTER.
- b. If you chose the location option, the next screen asks for the country or state/province (listed alphabetically) of the observing site.
- c. Use the Scroll keys to scroll through the list of countries, states, and provinces. Press ENTER

when the correct location displays.

- d. The next screen asks for the city (listed alphabetically) closest to the observing site. Use the Scroll keys to scroll through the list of cities. Press ENTER when the correct city appears on screen.
5. Daylight Savings Time: The next screen requests the status of Daylight Savings Time. If Daylight Savings Time is active, press the 1 key. If Daylight Savings Time is not active, press the 2 key.

Note: Daylight Savings Time may be referred to by a different name in various areas of the world.
6. Telescope Model: AudioStar then asks for the Telescope Model. Using the scroll keys on the AudioStar locate the model of your telescope and press enter.
7. Now enter the current date, then press ENTER.
8. Enter the current time. Select “AM,” “PM,” or 24-hour clock (blank). Then press ENTER.
9. With “Align: Easy” displayed, use the Scroll Keys to display “Align: Two Star”. Press Enter.
10. Setting the Home Position: “North Method: 1=True 2=Compass” displays. AudioStar is asking which Home Position method to use to setup the telescope. See page 9 “The Telescope Home Position” for more information. The easiest way to set the telescope in the home position is using the Magnetic North method. Follow the steps on page 9 to set the home position. If using True North, press the “1” key, or press the “2” key to use Magnetic North. Press enter when complete.
11. “Select Star” displays. AudioStar then displays a database of stars for the observer to choose from. Use the Scroll keys to scroll to a star on the list that you wish to align upon. Select a star that you can easily locate in the night sky. Press ENTER.
12. The telescope slews to the star. Use the Arrow keys to move the telescope until the star is centered in the eyepiece. Press ENTER.
13. Repeat procedure for the second alignment star. The telescope is aligned and you are now ready to use AudioStar’s GO TO capabilities for a night of observing.

LX65 TIPS

Too Much Power?

Can you ever have too much power? If the type of power you’re referring to is eyepiece magnification, yes, you can! The most common mistake of the beginning observer is to “overpower” a telescope by using high magnifications which the telescope’s aperture and atmospheric conditions cannot reasonably support. Keep in mind that a smaller, but bright and well-resolved image is far superior to one that is larger, but dim and poorly resolved (see images below). Powers above 300X should be employed only under the steadiest atmospheric conditions.

Most observers should have three or four additional eyepieces to achieve the full range of reasonable magnifications possible with the LX65 telescopes.

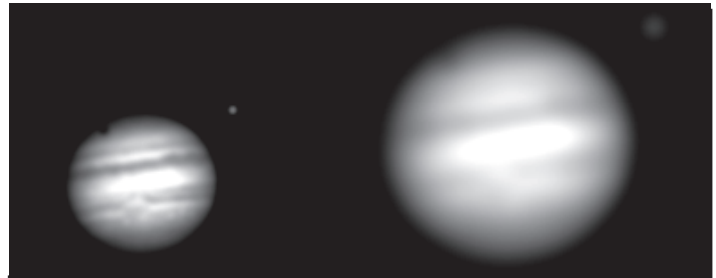

Jupiter; examples of the right amount of magnification and too much magnification.

One-Star Alt/Az Alignment

One-Star Alignment requires some knowledge of the night sky. AudioStar provides a database of bright stars. One-Star Alignment is identical to Two-Star Alt/Az: Alignment (see “Two-Star ALT/AZ Alignment,” above), except only one star from this database is chosen by the observer for alignment.

IMPORTANT NOTE : The accuracy of One-Star Alt/Az Alignment, unlike the Two-Star and Easy (Alt/Az) Alignment procedures, depends on how well the observer levels the telescope and how close to North the telescope is pointed when setting the Home Position (Pg. 9). Because the other methods use two stars to align upon, they are more precise than One-Star Alignment.

Browse

This menu allows you to search the database for objects with certain parameters, much like a search engine. “Edit Parameters” lets you set various parameters for the search, and “Start Search” activates the search. A typical search might be performed as follows:

1. Select “Browse” from the Object menu. Press ENTER. “Browse: Start Search” displays.
2. Press one of the Scroll Keys and “Browse: Edit Parameters” displays. Press Enter.
3. “Edit Parameters: Largest (mins)” displays. “Mins” stands for arc-minutes. Press ENTER.

MAINTENANCE

The LX65 is a precision optical instrument designed to yield a lifetime of rewarding viewing.

Given the care and respect due any precision instrument, the LX65 will rarely, if ever, require factory servicing. Maintenance guidelines include:

1. Avoid cleaning the telescope's optics: a little dust on the front surface of the telescope's correcting lens causes virtually no degradation of image quality and should not be considered reason to clean the lens.
2. When absolutely necessary, dust on the front lens should be removed with gentle strokes of a camel hair brush or blown off with an ear syringe (available at any pharmacy). DO NOT use a commercial photographic lens cleaner.
3. Organic materials (e.g., fingerprints) on the front lens may be removed with a solution of 3 parts distilled water to 1 part isopropyl alcohol. You may also add 1 drop of biodegradable dishwashing soap per pint of solution. Use soft, white facial tissues and make short, gentle strokes. Change tissues often.
4. CAUTION: Do not use scented or lotioned tissues that can damage the optics.
5. Do not, for any reason, remove the correcting plate from its machined housing for cleaning or other purposes. You will almost certainly not be able to replace the corrector in its proper rotational orientation and serious degradation of optical performance will result. Meade Instruments assumes no liability for damage incurred to the telescope in this way.
6. If the LX65 is used outdoors on a humid night, water condensation on the telescope surfaces will probably result. While such condensation does not normally cause any damage to the telescope, it is recommended that the entire telescope be wiped down with a dry cloth before the telescope is packed away. Do not, however, wipe any of the optical surfaces. Rather, simply allow the telescope to sit for some time in the warm indoor air, so that the wet optical surfaces can dry unattended.
7. If the LX65 is not to be used for an extended period, perhaps for one month or more, it is advisable to remove the batteries from the

telescope. Batteries left in the telescope for prolonged periods may leak, causing damage to the telescope's electronic circuitry.

8. Do not leave the LX65 inside a sealed car on a warm summer day; excessive ambient temperatures can damage the telescope's internal lubrication and electronic circuitry.

Collimation

The optical collimation (alignment) of any astronomical telescope used for serious purposes is important, but in the case of the Advanced Coma-Free design of the LX65 series, such collimation is absolutely essential for good performance. Take special care to read and understand this section well so that your LX65 will give you the best optical performance.

As part of final optical testing, every Meade LX65 is precisely collimated at the Meade factory before shipment. However, vibrations in shipping can cause the optical system to become misaligned. Re-aligning the optics is, however, a straightforward process.

To check the collimation of your LX65 telescope, center a bright star that is overhead, or use a "hot spot" of reflected Sunlight from a chrome car bumper, with the supplied 26mm eyepiece. Allow the telescope to adjust to the temperature of your observation site before proceeding; temperature differences between the optics and the outside air can cause distortion in the images.

With the star or hot spot centered, de-focus the image.

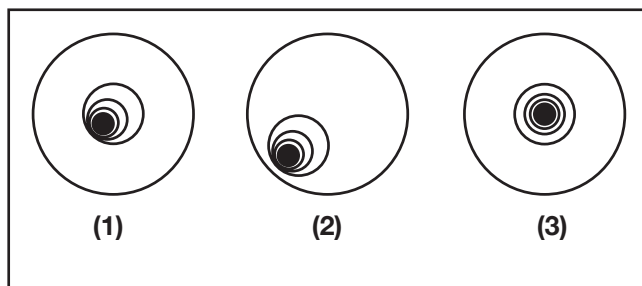

You will notice that the out of focus star image looks like a ring of light surrounding a dark central spot; the dark central spot is in fact the shadow of the secondary mirror. Turn the focus knob until the ring of light fills about 10% of the eyepiece field-diameter. If the dark central spot is offset in (i.e., not concentric with) the ring of light, your telescope's optical system is misaligned and requires collimation.

Collimating the ACF Optical System

1. The only adjustments possible, or necessary, on the ACF are from the three inner most screws located at the inner surface of the secondary mirror housing.

CAUTION: Do not force the three collimation screws past their normal travel and do not loosen them more than two full turns in a counterclockwise direction or the secondary mirror may come loose from its support.



You will find that the adjustments are very sensitive, usually requiring only one-half turn or less to produce the desired result.

2. While looking at the defocused star image, notice which direction the darker shadow is offset in the ring of light or notice which part of the ring is the thinnest. Place your index finger in front of the telescope so that it touches one of the collimation set screws. You will see the shadow of your finger in the ring of light. Move your finger around the edge of the black secondary mirror support until you see the shadow of the finger crossing the thinnest part of the ring of light. At this point, look at the front of the telescope where your finger is aiming. It will either be pointing directly at a set screw, or it will be between two set screws aiming at the set screw on the far side of the black secondary mirror support. This is the set screw that you will adjust.
3. Using the Arrow keys at the slowest slew speed, move the defocused image to the edge of the eyepiece field of view, in the same direction as the darker shadow is offset in the ring of light.
4. Turn the set screw that you found with the pointing exercise while looking in the eyepiece. You will notice that the star image will move across the field. If while turning the defocused star image flies out of the eyepiece field, then you are turning the screw the wrong way. Turn

the opposite direction and bring the image back to the center of the field.

5. If the screw you are turning becomes very loose, tighten the other two screws by even amounts. If the screw you are turning gets too tight, un-thread the other two by even amounts.
6. When you bring the image to center, carefully examine the evenness of the ring of light (concentricity). If you find that the dark center is still off in the same direction, continue to make the adjustment in the original turning direction. If it is now off in the opposite direction, you have turned too far and you need to turn in the opposite direction. Always double check the image in the center of the field of the eyepiece.
7. You may find after your initial adjustment that the dark center is off in a new direction (e.g., instead of being off side-to-side it is now off in an up-and-down direction). In this case repeat steps 2 through 6 to find the new adjustment screw.
8. Now try a higher power eyepiece (e.g., 9mm or less) and repeat the above tests. Any lack of collimation at this point will require only very slight adjustments of the three set screws. You now have good collimation of the optics.
9. As a final check on alignment, examine the star image in focus with the higher power eyepiece as suggested above, under good viewing conditions. The star point should appear as a small central dot (commonly referred to as an "Airy disc") with a diffraction ring surrounding it. To give a final precision collimation, make extremely slight adjustments of the three set screws, if necessary, to center the Airy disc in the diffraction ring. You now have the best alignment of the optics possible with this telescope.

Collimating the Maksutov-Cassegrain Optical System

The only optical component that can be adjusted in the LX65 Maksutov-Cassegrain is the tilt of the Primary Mirror. The front corrector and secondary mirror are permanently aligned. This makes collimation overall fairly straightforward. Follow these steps to inspect and adjust the alignment of your optical tube.

Collimate Using the Star Test

1. At night, point the telescope to a fairly bright star that is at least 60° above the horizon. This will ensure the star is above

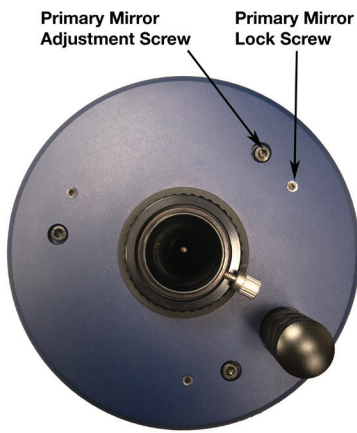

most of the turbulent layers of sky seen closer to the horizon. Allow the telescope to adjust to the temperature of your observation site before proceeding; temperature differences between the optics and the outside air can cause distortion in the images.

2. Center the star with the 26mm eyepiece, then switch to the 9mm eyepiece. We recommend aligning the Go-To on the LX65 so that you can keep the star centered during this process and easily re-center the star as needed with the AudioStar handbox.

Note: The star must be precisely centered in the eyepiece to accurately assess the collimation of the telescope.

3. Bring the star out of focus by about 1/2 turn on the focus knob. The defocused star pattern should look concentric, with the secondary mirror shadow centered to star pattern. Everything should look circular as it does in image (3) on the diagram on page 39. If the pattern is not concentric, or if it looks elliptical, you will need to make an adjustment to the primary mirror.

4. The primary mirror cell is adjusted using three adjustment screws and three locking screws. To collimate the primary mirror, first loosen each of the locking screws by turning them counterclockwise one full turn. Next make a small adjustment to the necessary adjustment screws and re-center the star in the eyepiece. Each adjustment screw can tilt the primary mirror and has limited range of adjustment. Using a 2.5mm and 4mm Allen wrench, make small adjustments until the defocused star image looks concentric. When complete lightly tighten all three locking knobs to secure the mirror in place. Do not overtighten.

Inspecting the Optics

A Note About the “Flashlight Test”: If a flashlight or other high-intensity light source is pointed down the main telescope tube, the view (depending upon the observer’s line of sight and the angle of the light) may reveal what appears to be scratches, dark or bright spots, or just generally uneven coatings, giving the appearance of poor quality optics. These effects are only seen when a high intensity light is transmitted through lenses or reflected off the mirrors, and can be seen on any high quality optical system, including giant research telescopes.

The optical quality of a telescope cannot be judged by the “flashlight test;” the true test of optical quality can only be conducted through careful star testing.

Gaging the Movement of the Telescope

A common complaint of many first-time telescope owners is that they cannot see the telescope “move” when the motor drive is engaged. In fact, when the batteries are installed, the power is on, the telescope is moving. However, the movement is at the same speed as the hour hand of a 24-hour clock; as such, the movement is difficult to discern visually.

To check the movement of your telescope, look at an astronomical object through the telescope’s eyepiece with the telescope polar aligned and with the motor drive on. If the object remains stationary in the field of view, your telescope is operating properly. If not, check to ensure that “Astronomical” is selected in the “Targets” option of the setup menu.

Updating Your LX65 Firmware

Meade is constantly refining and improving the operating firmware that controls our computerized telescopes and we even add new features and capabilities from time to time. Your new LX65 shipped with the most current firmware at the time of manufacture, but there may well be a new version available through the AutoStar Updater program supplied on the AutoStar Suite DVD supplied with your telescope. The Updater goes online to the Meade web site and checks to see if there is a newer version available and can download it directly to the telescope using the #505 Cable Connector Kit. See the instruction sheet included with the kit for more information.

CUSTOMER SERVICE

If you have a question concerning your LX65 telescope, call the Meade Instruments Customer Service Department at (800) 626-3233. Customer Service hours are 7:00 AM to 4:00 PM, Pacific Time, Monday through Friday. In the unlikely event that the LX65 requires factory servicing or repairs, before returning the telescope to the factory, write or call the Meade Customer Service Department to provide an explanation of the problem, as well as your name, address and daytime telephone number. The great majority of servicing issues can be resolved by telephone, avoiding return of the telescope to the factory.

APPENDIX A: TRAINING THE DRIVE

Perform this procedure if you are experiencing any pointing accuracy problems. The diagram to the right depicts the complete Drive Training procedure.

NOTE: Use a far away terrestrial object, such as a telephone pole or lamp post, to train the drive.

Complete this exercise once every 3 to 6 months.

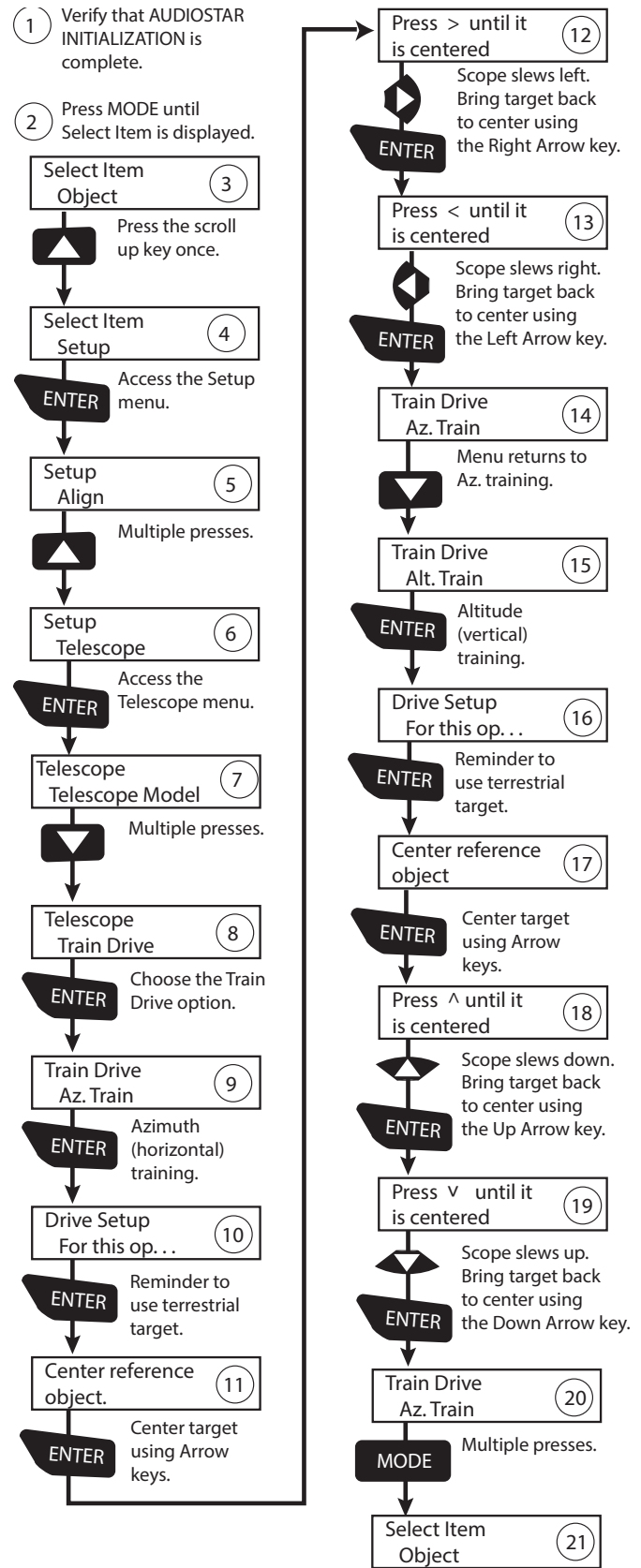

APPENDIX B:

BASIC ASTRONOMY

In the early 17th century Italian Scientist Galileo, using a crude telescope considerably smaller than the LX65 Series, turned it to look towards the sky instead of distant trees and mountains. What he saw, and what he realized about what he saw, forever changed the way mankind thought of the universe. Imagine what it must have been like being the first human to see moons revolve around the planet Jupiter or to see the changing phases of Venus! Because of his observations, Galileo correctly realized Earth's movement and position around the Sun, and in doing so, gave birth to modern astronomy. Yet Galileo's telescope was so crude, he could not clearly make out the rings of Saturn.

Galileo's discoveries laid the foundation for understanding the motion and nature of the planets, stars, and galaxies. Building on his foundation, Henrietta Leavitt determined how to measure the distance to stars; Edwin Hubble proposed a glimpse into the origin of the universe; Albert Einstein unraveled the relationship of time and light. Almost daily, using sophisticated successors to Galileo's crude telescope, such as the Hubble Space Telescope, more and more mysteries of the universe are being solved and understood. We are living in a golden age of astronomy.

Unlike other sciences, astronomy welcomes contributions from amateurs. Much of the knowledge we have on subjects such as comets, meteor showers, variable stars, the Moon and our solar system comes from observations made by amateur astronomers. So as you look through your Meade LX65 telescope, keep Galileo in mind. To him, a telescope was not merely a machine made of glass and metal, but something far more - a window through which the beating heart of the universe might be observed.

Objects in Space

Listed below are some of the many astronomical objects that can be seen with the LX65 Series



The Moon is, on average, a distance of 239,000 miles (380,000km) from Earth and is best observed during its crescent or half phase when Sunlight strikes the Moon's surface at an angle. It casts shadows and adds a sense of depth to the view. No shadows are seen during a full Moon, causing the overly bright Moon to appear flat and

rather uninteresting through the telescope. Be sure to use a neutral Moon filter when observing the Moon. Not only does it protect your eyes from the bright glare of the Moon, but it also helps enhance contrast, providing a more dramatic image.

Using the LX65 Series, brilliant detail can be observed on the Moon, including hundreds of lunar craters and maria, described below.

Craters are round meteor impact sites covering most of the Moon's surface. With no atmosphere on the Moon, no weather conditions exist, so the only erosive force is meteor strikes. Under these conditions, lunar craters can last for millions of years.

Maria (plural for mare) are smooth, dark areas scattered across the lunar surface. These dark areas are large ancient impact basins that were filled with lava from the interior of the Moon by the depth and force of a meteor or comet impact.

Twelve Apollo astronauts left their bootprints on the Moon in the late 1960's and early 1970's. However, no telescope on Earth is able to see these footprints or any other artifacts. In fact, the smallest lunar features that may be seen with the largest telescope on Earth are about one-half mile across.

Planets change positions in the sky as they orbit around the Sun. To locate the planets on a given day or month, consult a monthly astronomy magazine, such as *Sky and Telescope* or *Astronomy*. You can also consult LX65 for information about planets. Scroll to the “Object: Solar System” menu and scroll through the lists of planets. When a planet you are interested in displays, press “ENTER”. Use the Scroll keys to display information about the planet, such as the planet’s coordinates, and the rise and set times (Tip: enter a date in the Date menu and you can determine if a planet) will be visible during the night of the entered date by checking its rise and set times). Listed below are the best planets for viewing through the LX65 Series.

Mars is about half the diameter of Earth, and appears through the telescope as a tiny reddish-orange disk. It may be possible to see a hint of white at one of the planet’s Polar ice caps. Approximately every two years, when Mars is closest to Earth in its orbit, additional detail and coloring on the planet’s surface may be visible.



Jupiter is the largest planet in our solar system and is 11 times the diameter of Earth. The planet appears as a disk with dark lines stretching across the surface. These lines are cloud bands in the atmosphere. Four of Jupiter’s 16 moons (Io, Europa, Ganymede, and

Callisto) can be seen as “star-like” points of light when using even the lowest magnification. These moons orbit Jupiter so that the number of moons visible on any given night changes as they circle around the giant planet.

Saturn is nine times the diameter of Earth and appears as a small, round disk with rings extending out from either side. In 1610, Galileo, the first person to observe Saturn through a telescope, did not understand that what he was seeing were rings. Instead, he believed that Saturn had “ears.” Saturn’s rings are composed of billions of ice particles ranging in size from a speck of dust to the size of a house. The major division in Saturn’s rings, called the Cassini Division, is occasionally visible through the LX65 Series. Titan, the largest of Saturn’s 18

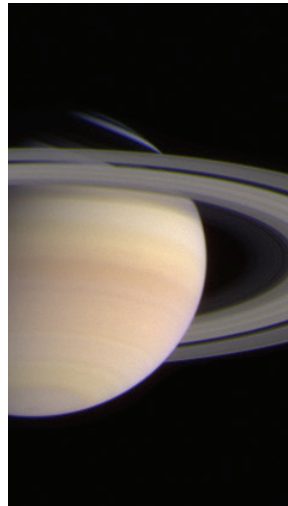

moons can also be seen as a bright, star-like object near the planet.

Deep-Sky Objects

Star charts can be used to locate constellations, individual stars and deep-sky objects.

Examples of various deep-sky objects are given below:

Stars are large gaseous objects that are self-illuminated by nuclear fusion in their core. Because of their vast distances from our solar system, all stars appear as pinpoints of light, irrespective of the size of the telescope used.

Nebulae are vast interstellar clouds of gas and dust where stars are formed. Most impressive of these is the Great Nebula in Orion (M42), a diffuse nebula that appears as a faint wispy gray cloud. M42 is 1600 light years from Earth.

Open Clusters are loose groupings of young stars, all recently formed from the same diffuse nebula. The Pleiades is an open cluster 410 light years away. Through the LX65 Series, numerous stars are visible. Constellations are large, imaginary patterns of stars believed by ancient civilizations to be the celestial equivalent of objects, animals, people, or gods. These patterns are too large to be seen through a telescope. To learn the constellations, start with an easy grouping of stars, such as the Big Dipper in Ursa Major. Then, use a star chart to explore across the sky.

Galaxies are large assemblies of stars, nebulae, and star clusters that are bound by gravity. The most common shape is spiral (such as our own Milky Way), but galaxies can also be elliptical, or even irregular blobs. The Andromeda Galaxy (M31) is the closest spiral-type galaxy to our own. This galaxy appears fuzzy and cigar-shaped. It is 2.2 million light years away in the constellation Andromeda, located between the large “W” of Cassiopeia and the great square of Pegasus.

APPENDIX C:

SPECIFICATIONS

Model and Product Number	LX65 with 5" Maksutov-Cassegrain #228001
Optical System	
Optical Design	Maksutov-Cassegrain
Primary Mirror Diameter	5" (127mm)
Primary Mirror Material	Borosilicate Glass
Focal Length, Focal Ratio	1900mm, f/15
Optical Coatings	Ultra-High Transmission Coatings (UHTC™)
Resolving Power (arc seconds)	0.91
Limiting Visual Stellar Magnitude	12.5
Viewfinder	Red Dot
Mount	
Mount Type	Aluminum Single-Arm Fork Altazimuth
Drives	4.64 inch Precision Worm Drive
Power	8 "C" Cell Batteries or AC Adapter
Tripod	New Adjustable-Height Steel Leg Tripod
Electronics	
Controller Hand Box	AudioStar
Included Accessories	
Eyepiece Holder	1.25" Diagonal Mirror
Eyepiece	Super Plössl 26mm
SC Adapter	Thread to 1.25" Accessory Adapter
Weight	
Fully Assembled	34.2 lbs.
Optical Tube	6.7 lbs.

APPENDIX C:

SPECIFICATIONS

Model and Product Number	LX65 with 6" Maksutov-Cassegrain #228002
Optical System	
Optical Design	Maksutov-Cassegrain
Primary Mirror Diameter	6" (152mm)
Primary Mirror Material	Borosilicate Glass
Focal Length, Focal Ratio	1800mm, f/12
Optical Coatings	Ultra-High Transmission Coatings (UHTC™)
Resolving Power (arc seconds)	0.76
Limiting Visual Stellar Magnitude	12.9
Viewfinder	Red Dot
Mount	
Mount Type	Aluminum Single-Arm Fork Altazimuth
Drives	4.64 inch Precision Worm Drive
Power	8 "C" Cell Batteries or AC Adapter
Tripod	New Adjustable-Height Steel Leg Tripod
Electronics	
Controller Hand Box	AudioStar
Included Accessories	
Eyepiece Holder	1.25" Diagonal Mirror
Eyepiece	Super Plössl 26mm
SC Adapter	SC Thread to 1.25" Accessory Adapter
Weight	
Fully Assembled	40.2 lbs.
Optical Tube	12.7 lbs.

APPENDIX C:

SPECIFICATIONS

Model and Product Number**LX65 with 6" ACF #228003****Optical System**

Optical Design	Advanced Coma-Free
Primary Mirror Diameter	6" (152mm)
Primary Mirror Material	Borosilicate Glass
Focal Length, Focal Ratio	1524mm, f/10
Optical Coatings	Ultra-High Transmission Coatings (UHTC™)
Resolving Power (arc seconds)	0.76
Limiting Visual Stellar Magnitude	12.9
Viewfinder	Red Dot

Mount

Mount Type	Aluminum Single-Arm Fork Altazimuth
Drives	4.64 inch Precision Worm Drive
Power	8 "C" Cell Batteries or AC Adapter
Tripod	New Adjustable-Height Steel Leg Tripod

Electronics

Controller Hand Box	AudioStar
---------------------	-----------

Included Accessories

Eyepiece Holder	1.25" Diagonal Mirror
Eyepiece	Super Plössl 26mm
SC Adapter	SC Thread to 1.25" Accessory Adapter

Weight

Fully Assembled	37.8 lbs.
Optical Tube	9.9 lbs.

APPENDIX C:

SPECIFICATIONS

Model and Product Number**LX65 with 8" ACF #228004****Optical System**

Optical Design	Advanced Coma-Free
Primary Mirror Diameter	8" (203mm)
Primary Mirror Material	Borosilicate Glass
Focal Length, Focal Ratio	2032mm, f/10
Optical Coatings	Ultra-High Transmission Coatings (UHTC™)
Resolving Power (arc seconds)	0.57
Limiting Visual Stellar Magnitude	13.5
Viewfinder	Red Dot

Mount

Mount Type	Aluminum Single-Arm Fork Altazimuth
Drives	4.64 inch Precision Worm Drive
Power	8 "C" Cell Batteries or AC Adapter
Tripod	New Adjustable-Height Steel Leg Tripod

Electronics

Controller Hand Box	AudioStar
---------------------	-----------

Included Accessories

Eyepiece Holder	1.25" Diagonal Mirror
Eyepiece	Super Plössl 26mm
SC Adapter	SC Thread to 1.25" Accessory Adapter

Weight

Fully Assembled	39.5 lbs
Optical Tube	11.6 lbs.

APPENDIX D: LX65 OPTICAL SYSTEMS

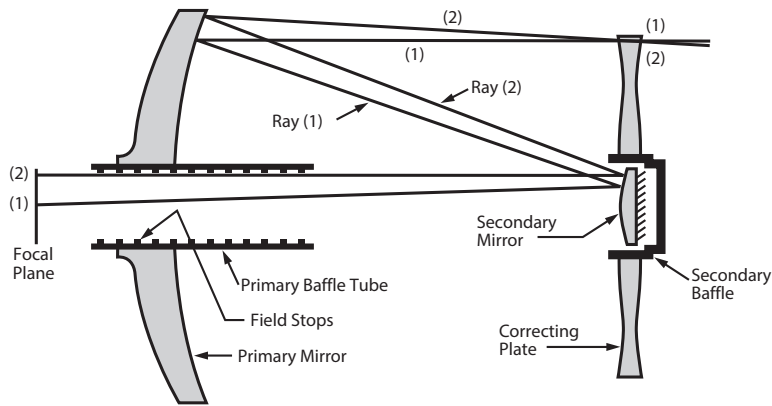

The Meade Advanced Coma-Free Optical System

Unlike Schmidt-Cassegrain systems, Meade's Advanced Coma-Free (ACF) optical system provides razor-sharp pin-point star images all the way to the very edge of the field of view. This aplanatic (coma-free) optical system brings the highest level of performance to the amateur astronomer.

In the ACF design of the Meade LX65 telescope, light enters from the right, passes through a thin lens with 2-sided aspheric correction ("correcting plate"), proceeds to a spherical primary mirror, and then to a hyperbolic secondary mirror. The hyperbolic secondary mirror multiplies the effective focal length of the primary mirror and results in a focus at the focal plane, with light passing through a central perforation in the primary mirror.

All models of the Meade ACF includes oversize primary mirrors, yielding a fully illuminated field-of-view significantly wider than is possible with a standard-size primary mirror. Note that light ray (2) in the figure would be lost entirely, except for the oversize primary. It is this phenomenon which results in Meade ACF having off-axis field illuminations about 10% greater, aperture-for-aperture, than other systems utilizing standard-size primary mirrors. Field stops machined into the inside-diameter surface of the primary mirror baffle tube significantly increase lunar, planetary, and deep-space image contrast. These field stops effectively block off-axis stray light rays.

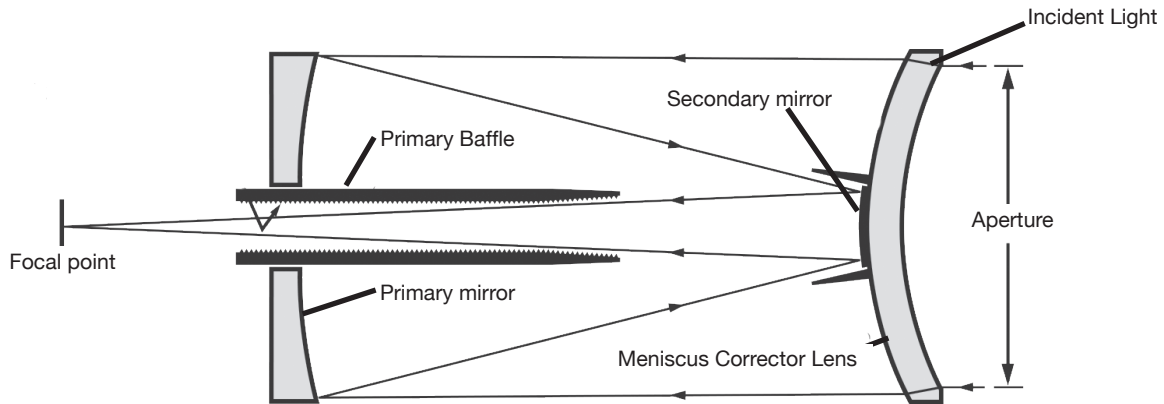

The Meade Maksutov-Cassegrain Optical System

In the Maksutov-Cassegrain design of the Meade LX65, light enters from the right through a multi-coated meniscus lens, proceeds to an f/2.2 primary mirror, and then to a convex secondary mirror that multiplies effective focal length by a factor of 6.3. The secondary mirror light baffle, in combination

with the anti-reflection threads inside the primary mirror baffle, produces extremely high contrast astronomical images at the focal plane.

APPENDIX E:

Using the LX65 with Two Optical Tubes



The LX65 is equipped with a second dovetail saddle to allow attachment of a second optical tube assembly. The optical tube must have a Vixen-style dovetail plate to attach to the LX65. The practical weight limit for the second optical tube is 7 lbs.

Loosen the Dovetail Locking Knob and insert the optical tube. Make sure the dovetail plate is flat against the saddle and tighten the Dovetail Locking Knob.

Aligning the Second Optical Tube

You may need to make small horizontal and vertical adjustments to the second optical tube's positioning so that both optical tubes are aligned to one another. Similar to aligning the Red Dot Finder, you must first select a distant target such as a power pole during the day or a bright star at night.

1. Center your target in the eyepiece of the main LX65 optical tube.

2. Carefully rotate both Vertical Adjustment Knobs in the same direction at the same time (the front knob uses left-handed threads and the rear knob uses right-handed threads). Turn the knobs very gradually. Only a small amount of adjustment should be needed so that the two optical tubes are aligned vertically.

3. Check that the Dovetail Locking Knob is still secure after the vertical alignment adjustment and retighten if necessary.

4. Slightly loosen the Horizontal Lock Knobs.

5. Turn the Horizontal Adjustment Knob as needed so that the target is centered in the eyepiece of both optical tubes.

6. Retighten the Horizontal Lock Knobs. Check that both optical tubes are secure with both Dovetail Locking Knobs securely tightened.

NOTE: Always rotate Vertical Adjustment Knobs in the same direction, at the same time, and with the same magnitude.

Always take caution when making the vertical adjustment and to support the OTA as needed. Only small adjustment should be needed.

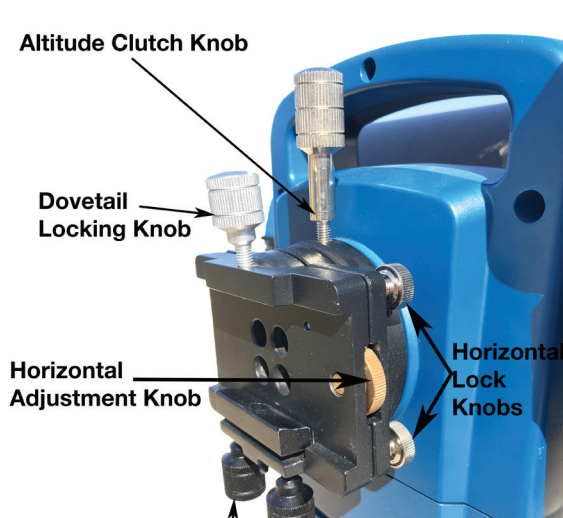

RECYCLING INFORMATION

(EU Countries only)

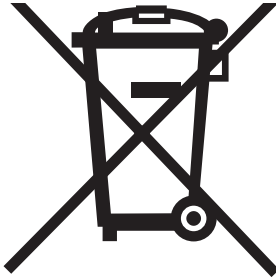

Correct Disposal of this Product

(Waste Electrical & Electronic Equipment)

This marking shown on the product or its literature indicates that it must not be disposed of in unsorted municipal waste at the end of its working life

To prevent possible harm to the environment or human health from uncontrolled waste disposal, please separate this from other types of wastes and recycle it as required by law. Household users should contact either the retailer where they purchased this product, or their local government office, for details of where and how they can take this item for environmentally

safe recycling. Business users should contact their supplier and check the terms and conditions of the purchase contract

This product should not be mixed with other commercial wastes for disposal.

Meade Limited Warranty

Every Meade telescope, spotting scope, and telescope accessory is warranted by Meade Instruments Corp ("Meade") to be free of defects in materials and workmanship for a period of ONE YEAR from the date of original purchase in the U.S.A. and Canada. Meade will repair or replace a product, or part thereof, found by Meade to be defective, provided the defective part is returned to Meade, freight-prepaid, with proof of purchase. This warranty applies to the original purchaser only and is non-transferable. Meade products purchased outside North America are not included in this warranty, but are covered under separate warranties issued by Meade international distributors.

RGA Number Required: Prior to the return of any product or part, a Return Goods Authorization (RGA) number **must** be obtained from Meade by writing, or by calling (800) 626-3233. Each returned part or product must include a written statement detailing the nature of the claimed defect, as well as the owner's name, address, and phone number.

This warranty is not valid in cases where the product has been abused or mishandled, where unauthorized repairs have been attempted or performed, or where depreciation of the product is due to normal wear-and-tear. Meade specifically disclaims special, indirect, or consequential damages or lost profit which may result from a breach of this warranty. Any implied warranties which cannot be disclaimed are hereby limited to a term of one year from the date of original retail purchase.

This warranty gives you specific rights. You may have other rights which vary from state to state.

Meade reserves the right to change product specifications or to discontinue products without notice.

This warranty supersedes all previous Meade product warranties.



We appreciate your business. Keep in touch!



@meadeinstruments



@meadeinstruments

Let's get social:



@meadeinstrument

Share your photos with us:

#MeadeMoments

Social@meade.com

For special offers and other products, visit our website

www.meade.com



MEADE[®]

27 Hubble, Irvine, California 92618
(800) 626-3233 ■ www.meade.com

August 2018 REV 1

14-2713-00