

Instruction Manual

8", 10", 12", 16" LightBridge™ Truss Tube
Dobsonian Telescopes



MEADE.COM





WARNING!

Never use a Meade® to look at the Sun! Looking at or near the Sun will cause instant and irreversible damage to your eye. Eye damage is often painless, so there is no warning to the observer that damage has occurred until it is too late. Do not point the telescope at or near the Sun. Do not look through the telescope or SmartFinder™ as it is moving. Children should always have adult supervision while observing.

CONTENTS

Telescope Features	8
Assembly	5
Assemble the Base	5
Assemble the Tube	6
Insert Eyepiece, Attach Red Dot Finder	7
Collimating the Optical System	8
Align the deluxe Red Dot Finder	11
Using a Dobsonian Telescope	11
Calculate Magnification	12
Observing	12
Some Tips	15
Care of the Optics	15
Meade Customer Service	16
Specifications	17
Optional Accessories	19
Appendix A: Altitude Adjustment Knobs	21

WARNING!

Never leave the primary mirror uncovered during the daytime unless using the telescope to view terrestrial objects.

® The name "Meade" and the Meade logo are trademarks registered with the U.S. Patent and Trademark Office and in principal countries throughout the world. "LightBridge " is a trademark of Meade Instruments Corporation.

© 2006 Meade Instruments Corporation.

Fig. 1 Telescope features.

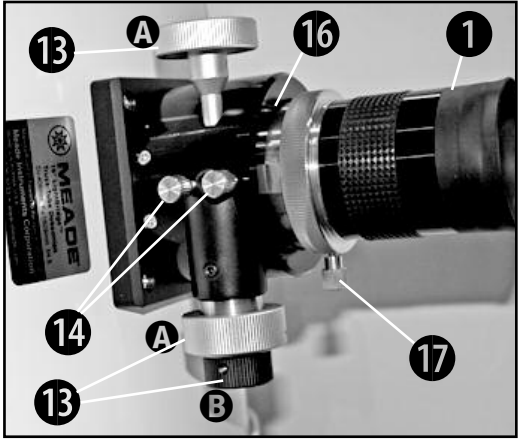
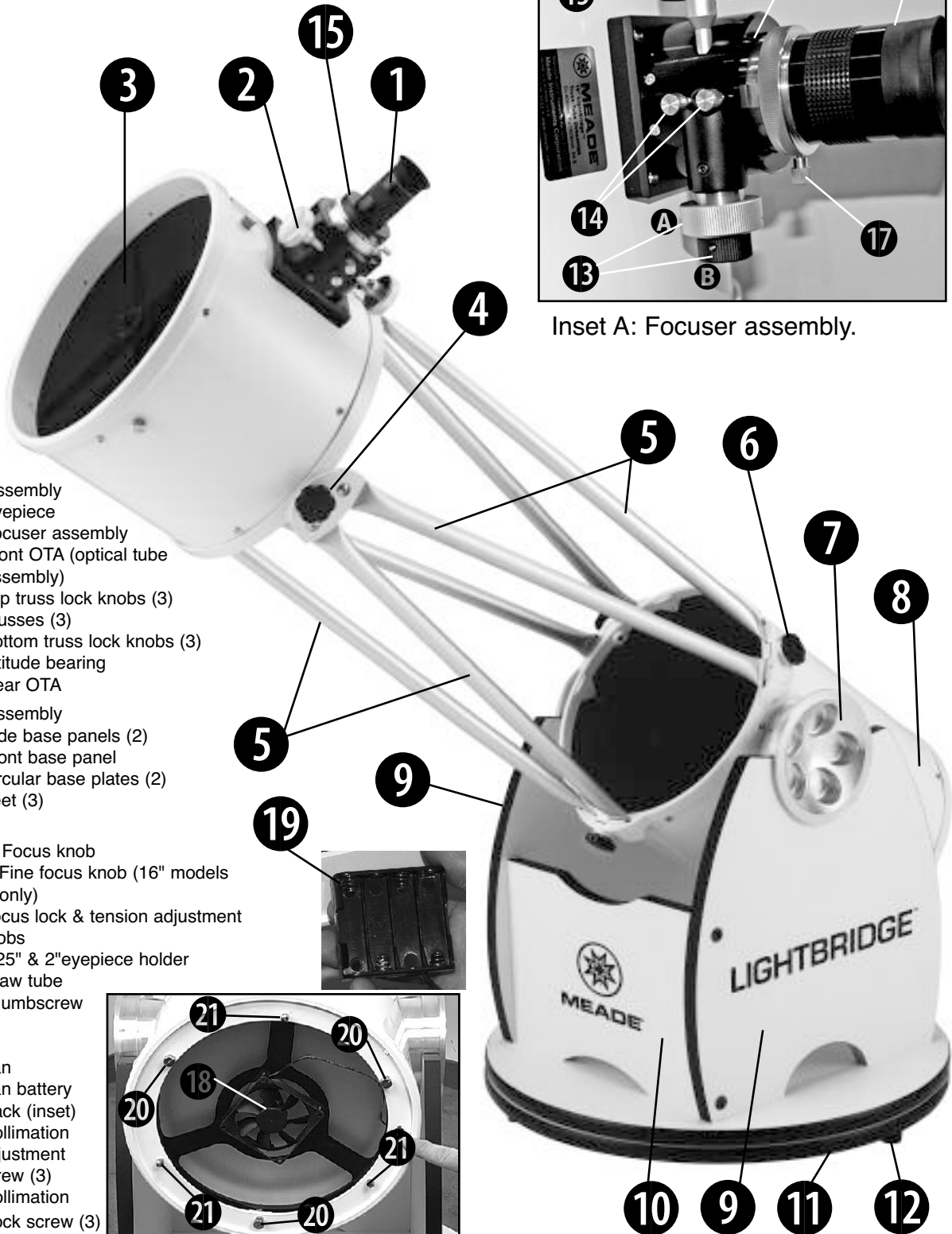

Inset A: Focuser assembly.

- Tube Assembly**
- 1. Eyepiece
 - 2. Focuser assembly
 - 3. Front OTA (optical tube assembly)
 - 4. Top truss lock knobs (3)
 - 5. Trusses (3)
 - 6. Bottom truss lock knobs (3)
 - 7. Altitude bearing
 - 8. Rear OTA
- Base Assembly**
- 9. Side base panels (2)
 - 10. Front base panel
 - 11. Circular base plates (2)
 - 12. Feet (3)

- Inset A**
- 13. a) Focus knob
b) Fine focus knob (16" models only)
 - 14. Focus lock & tension adjustment knobs
 - 15. 1.25" & 2" eyepiece holder
 - 16. Draw tube
 - 17. Thumbscrew

- Inset B**
- 18. Fan
 - 19. Fan battery pack (inset)
 - 20. Collimation adjustment screw (3)
 - 21. Collimation Lock screw (3)

Inset B: Base of mirror tube (see page 9 for 16" base information).

ASSEMBLY

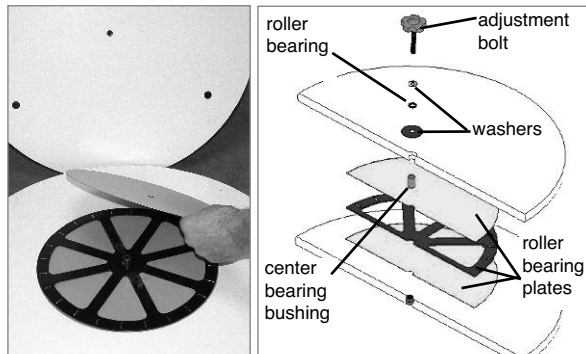
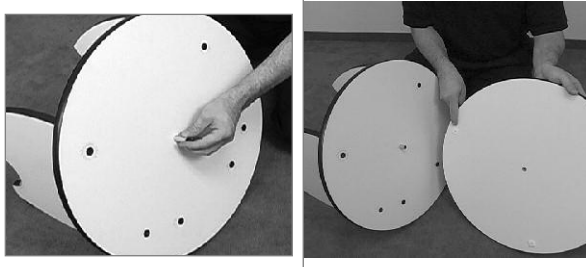
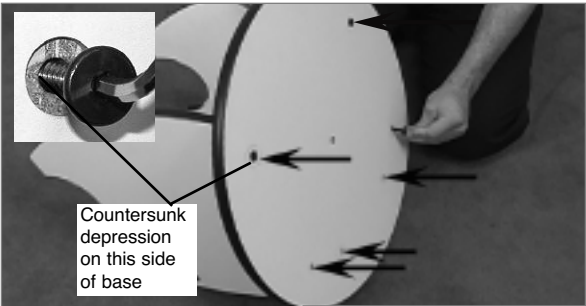

ASSEMBLE THE BASE

Note: You will need to supply a phillips screwdriver and a one-quarter inch or adjustable wrench to assemble the telescope.

Note: Numbers in parentheses. e.g., (9), refer to Fig.1 and Fig. 1 insets.

STEP 1: The base supports the telescope and allows you to move the telescope from side to side.

Line up one of the base side panels (9) with the base front panel (10) as shown here. Thread in the two black attachment bolts to secure the panels together. Tighten the bolts to a firm feel.

Repeat with second side panel.

STEP 2: Turn the base panels on their side.

Line up the circular base(11) with the 7 predrilled holes against the panels.

Thread 6 black bolts into the base, as shown here. Make sure that the side with the countersunk holes on the base face the bottom (see photo)

STEP 3:

Slide the center bearing bushing into the 7th (center) hole of the circular base.

Line up the other circular base (sometimes called the ground base), which contains three teflon pads (finger points to a pad)

STEP 4:

Place the center bearing bushing into the countersunk hole of the ground plate. Slide the three roller bearing plates over the center bearing bushing: First the roller bearing plate, then the roller bearing itself (the plate that looks alike a wagon wheel), then the second roller bearing plate. Place the top part of the base plate assembly over the center bearing bushing. To secure in place: On the adjustment knob bolt, place two washers on either side of the roller bearing washer. Slide the adjustment bolt through the top base board and into the center bearing bushing and hand-tighten. A nut is captured on the bottom plate. See drawing

STEP 5: Next attach the three feet to the bottom panel. Line up each foot and thread a small attachment screw into the foot to hold it in place. Tighten to a firm feel.

Note: When attaching the feet, make sure that the center countersink depression is on the opposite side of the base.

STEP 5: Next attach the three feet to the bottom panel. Line up each foot and thread a small attachment screw into the foot to hold it in place. Tighten to a firm feel.



Looking at or near the **Sun** will cause **irreversible** damage to your eye. Do not point this telescope at or near the Sun. Do not look through the telescope as it is moving.

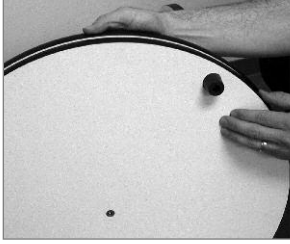

STEP 6: Move the circular panels. They should move easily about, without any stiffness. If not, tighten or loosen them using a screwdriver while holding the attachment nut in place (with your fingers or a wrench) on the other end of the bolt.

ASSEMBLE THE TUBE

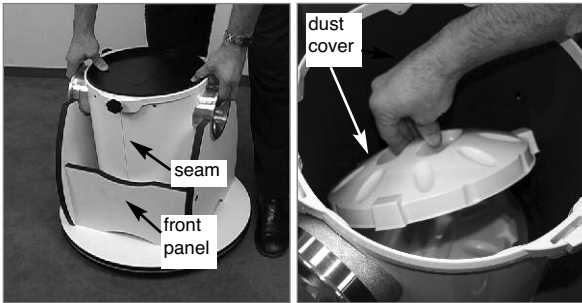

STEP 7: Turn the base so that it is now resting on the feet.

Place the rear OTA (8) into the base. Make sure that the altitude bearings fit snugly into the openings on the side panels of the base. Make sure that the seam of the tube is pointing at the front panel.

Lift to remove the dust cover from the mirror.

Note: You can thread the Altitude Adjustment Knob into the protrusion just below the Altitude Bearing (7). Use the Altitude Adjustment Knob when you add larger eyepieces, cameras or other accessories to the Meade LightBridge telescope without causing the tube to slip or drift. To learn how to install the Altitude Adjustment Knob, see page 21.

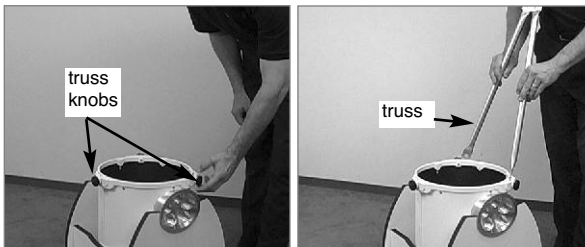

STEP 8: Loosen the three bottom truss knobs (6).

Place each truss (5) into a set of slots.

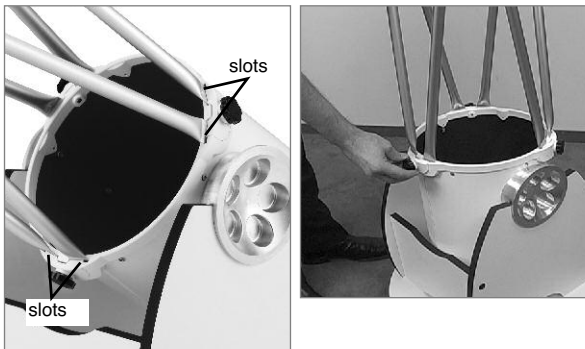

Tighten the truss knobs after all three trusses are in place.

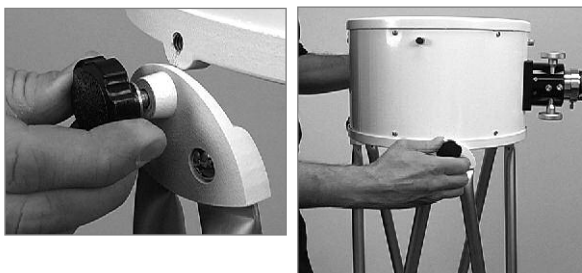

STEP 9: After all 3 trusses are in place, loosen the knob (4) on top of each truss.

Place the secondary mirror tube (3) into the slots at the top of each truss....

STEP 10: ...and tighten the truss knobs.

Make sure that the seam on the tube is also pointing towards the front panel (see step 7).



INSERT EYEPIECE AND ATTACH RED DOT FINDER



STEP 10: The entire assembly should move easily up and down and from side to side.

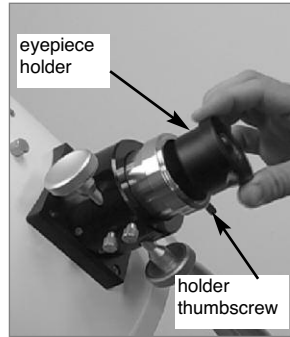

STEP 11: If you wish to insert the deluxe 2 inch eyepiece, remove the 1.25" eyepiece holder (15) from the focuser assembly by loosening holder thumbscrew (as shown in photo to the left). Slide the 2 inch eyepiece into the focuser and tighten with the eyepiece locking screw. To focus the eyepiece, turn the focuser wheels (13) in or out.

The focuser has both a lock knob and a tension adjustment knob. The first lock prevents the draw tube (16) from moving in and out. The second lock locks the focuser knob, thereby locking a focus position into place. Experiment with these knobs to discover which adjustments are comfortable with your viewing style.

Note that the 16" model comes with a two-speed focuser. Use the large focus wheel (13A) for fast focus and the small focus knob (13B) for fine focus.

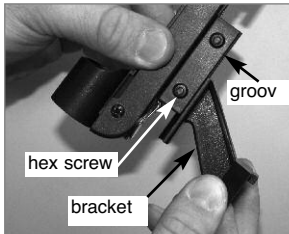

STEP 12: A red dot finder projects a red dot in place of crosshairs, to make it easier to line up more precisely with a target.

First, assemble the red dot finder. Slide the bracket over the groove of the red dot finder scope. Tighten the two hex screws with the supplied hex wrench to secure in place.

Slide the red dot finder bracket into the slot on the top OTA. Slide it in from the top (it will only go into the slot from this end). Tighten the thumbscrew to hold the red dot bracket securely in place. You will need to align the red dot finder. See page 8.

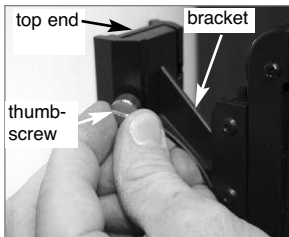

STEP 13: To move the telescope, remove the tube assembly from the base assembly. Grasp the tube assembly by the trusses and lift up. It is recommended that you relocate the telescope when it is disassembled into two pieces.

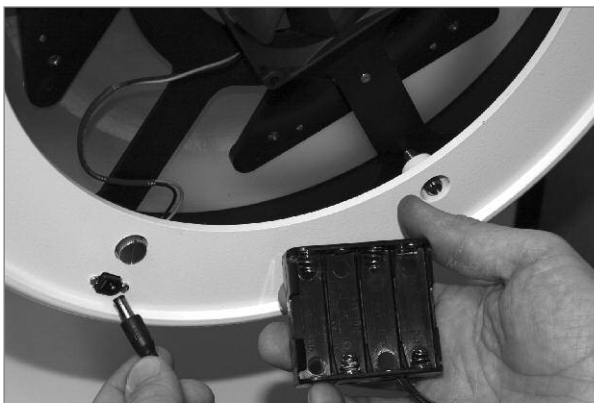

STEP 14: Note that there is a fan on the bottom of the mirror tube. It is powered by a battery pack using 4 AA user-supplied batteries.

If you begin observing at sunset, and the telescope has been heated by the sun or by being in your car, you may notice "turbulence" in your images. In this case, you can run the fan until your images stabilize and are steady. The fan probably needs to be used less than an hour.

Note also that there are three lock screws and three collimation screws. These screws are for use with the collimation procedure. See page 14.



Looking at or near the **Sun** will cause **irreversible** damage to your eye. Do not point this telescope at or near the Sun. Do not look through the telescope as it is moving.

COLLIMATION OF THE OPTICAL SYSTEM

Precise collimation, or alignment, of your telescope's optical system is essential for good performance. All Meade telescopes are accurately collimated at the factory prior to shipment. You may want to collimate after the telescope has been shipped or if it has endured rough handling or a bumpy car journey—usually, though, just a small touch up is all that's required.

Meade offers an optional laser collimator to help you to collimate your telescope (see **OPTIONAL ACCESSORIES**, page 18). Nevertheless, take the time now to familiarize yourself with the following collimation procedure so that you may recognize a properly collimated instrument and adjust the collimation yourself, if necessary.

Correct Collimation

The collimation procedure for the Meade LightBridge Dobsonian is slightly different from that of other Newtonian reflecting telescopes, because of the "fast" f/5 to f/6 focal ratio of the primary mirror. In typical Newtonian reflectors with more conventional focal ratios (i.e. longer focal ratios), when the observer looks down the focuser tube (without an eyepiece in the focuser), the images of the diagonal mirror, primary mirror, focuser tube and the observer's eye appear centered relative to each other.

However, with the short focal ratio primary mirror of the LightBridge Dobsonian, correct collimation requires that the diagonal mirror be offset in 2 directions: (1) away from the focuser and (2) towards the primary mirror, in equal amounts. This offset is approximately 1/8" in each direction. Note that these offsets have been performed at the factory prior to shipment of your telescope. It is only necessary for you to confirm that the telescope has not been badly jarred out of collimation, and to perform the final fine-tuning of Step 4, below.

Fig. D shows a correctly collimated LightBridge Dobsonian telescope, as it appears when viewed through the focuser *with the eyepiece removed*.

To check and, if necessary, set the optical collimation, follow these steps:

1. Observe through the focuser and orient your body so that the telescope's primary mirror is to your right, and the open end of the telescope tube is to your left.

The diagonal mirror will appear centered as shown (**2, Fig. D**). If the diagonal appears off center, then adjust the 3 collimation screws (**2, Fig. B**) on the plastic diagonal mirror housing.

2. If the reflection of the primary mirror (**3, Fig. D**) is not centered on the surface of the diagonal mirror, adjust the 3 collimation adjustment screws on the diagonal mirror housing to center the reflection.

As described above, the 3 collimation screws on the diagonal mirror housing are used for two different adjustments during the collimation procedure.

Important Note: Do not force the 3 screws past their normal travel, and do not rotate any screw or screws more than 2 full turns in a counterclockwise direction (i.e., not more than 2 full turns in their "loosening" direction), or else the diagonal mirror may become loosened from its support. Note that the diagonal mirror collimation adjustments are very sensitive: generally turning a collimation screw 1/2-turn will have a dramatic effect on collimation.

3. If the reflection of the diagonal mirror is not centered within the reflection of the primary mirror, adjust the 3 collimation adjustment screws (**20, Fig. C**) located on the rear of the primary mirror cell.

Proceed by "trial and error" until you develop a feel for which collimation screw to turn in order to change the image in any given way.

4. Perform an actual star test to confirm the accuracy of steps 1 through 3. Using the 26mm eyepiece, point the telescope at a moderately bright (second or third magnitude) star, and center the image in the main telescope's field of view.

Note: A small paper ring is attached to the primary mirror. This ring was attached at the factory for purposes of laser collimation. The ring will not diminish your telescope's imaging capabilities and does not need to be removed.



Looking at or near the **Sun** will cause **irreversible** damage to your eye. Do not point this telescope at or near the Sun. Do not look through the telescope as it is moving.

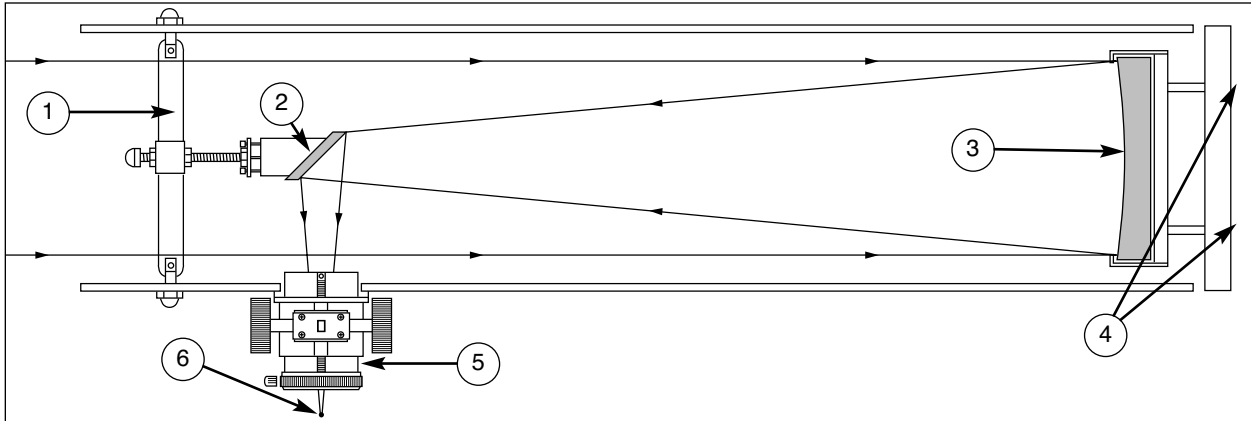

Fig. A: Newtonian Reflecting Telescope. (1) Spider Vanes; (2) Secondary Mirror; (3) Parabolic Primary Mirror; (4) Primary Mirror Hex Screws; (5) Focuser Drawtube; (6) Focused Image.

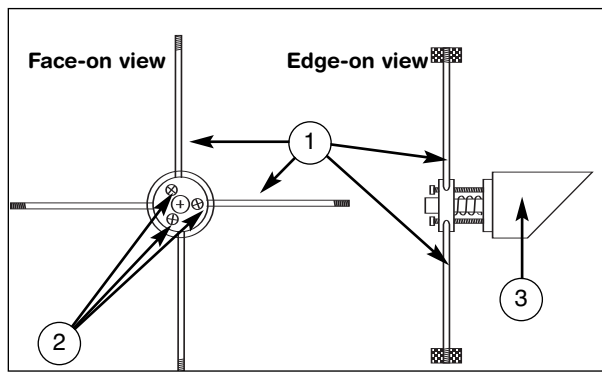

Fig. B: Secondary Mirror Assembly. (1) Spider Vanes; (2) Tilt Screws; (3) Secondary Mirror Holder.

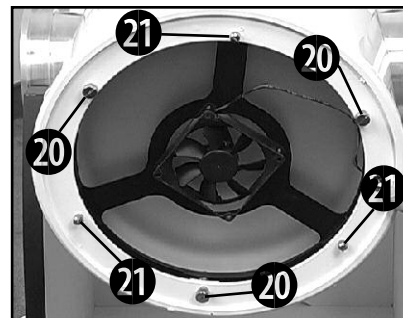
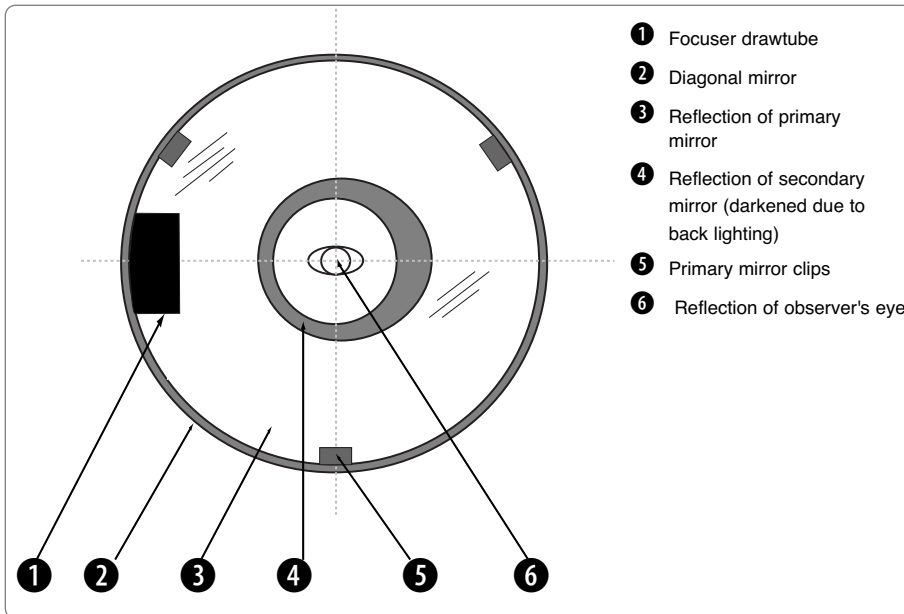

Fig. C: Underside of rear mirror tube (primary mirror housing): (20) Collimation Adjustment Screw; (21) Collimation Lock Screw



- ① Focuser drawtube
- ② Diagonal mirror
- ③ Reflection of primary mirror
- ④ Reflection of secondary mirror (darkened due to back lighting)
- ⑤ Primary mirror clips
- ⑥ Reflection of observer's eye



Fig. E: Some models come with knobs instead of screws. Use the black knobs to adjust collimation and the white knobs to lock collimation.

Fig. D: The view you will see while collimating your telescope.



Looking at or near the **Sun** will cause **irreversible** damage to your eye. Do not point this telescope at or near the Sun. Do not look through the telescope as it is moving.

5. Bring the star's image slowly in and out of focus until you see several disks surrounding the star's center. If steps 1 through 3 were done correctly, you will see concentric (centered with respect to each other) circles (1, Fig. F).

An improperly collimated instrument will reveal oblong or elongated circles (2, Fig.F). Adjust the 3 collimating screws on the primary mirror housing until the circles are concentric on either side of the focus.

In summary, the adjustment screws on the plastic diagonal mirror housing change the tilt of the secondary mirror so that it is correctly centered in the focuser drawtube, and so that the primary mirror appears centered when looking into the focuser.

The 3 collimating knobs on the primary mirror change the tilt of the primary mirror so that it reflects the light directly up the center of the drawtube.

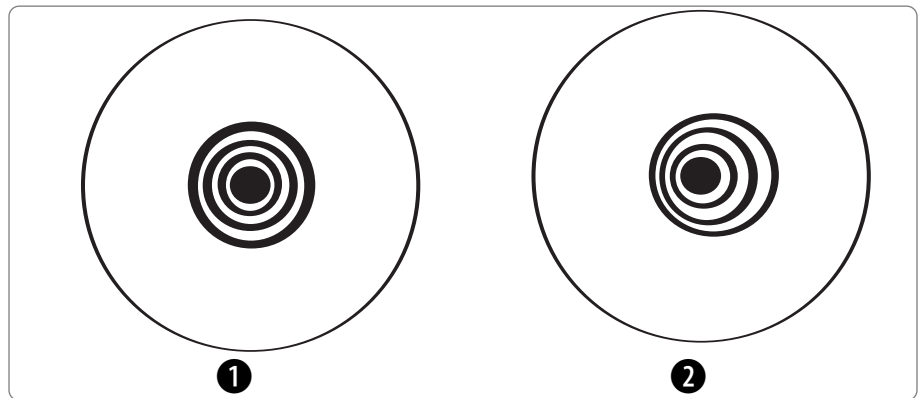
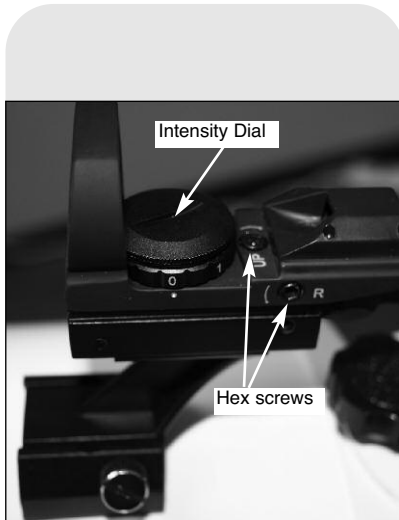

Fig. F: Correct (1) and incorrect (2) collimation as viewed during a star test.





The deluxe red dot finder.

ALIGN THE DELUXE RED DOT FINDER

See step #12, page 7 to find out how to attach the finder to the telescope.

It is recommended that you perform steps 1 and 2 of this procedure during the daytime and step 3 at night.

1. If you have not already done so, place the low-power (26mm) eyepiece in the eyepiece holder (15) and point the telescope at an easy-to-find land object (*e.g.*, the top of a telephone pole). Turn the focuser knob (13A) so that the image is sharply focused. Center the object precisely in the main telescope's field of view.
2. Then, looking through the red dot finder, adjust one or both of the hex screws on the top and side of the finder until the finder's red dot points precisely at the same object as centered in the main telescope. Rotate the dial on top of the finder to change the intensity of the indicator. The red dot finder is now aligned to the main telescope.
3. Check this alignment on a celestial object, such as the Moon or a bright star, and make any necessary refinements.

The deluxe red dot finder provides you with four different red dot indicator shapes: a dot, a cross, a diamond and a bullseye. Push the lever below the finder to change the shape of the dot.

USING A DOBSONIAN TELESCOPE

1. Never lubricate the Teflon pads on the ground plate. Your Dobsonian has been designed with some inherent friction. You want the telescope to move easily when you position it, but you also want it to stay in the position you place it. Using any kind of oil, silicone spray, wax, or grease will ruin the performance by causing the telescope to move too easily. Just keep these bearing surfaces clean; that's all the maintenance required.
2. The altitude bearing surfaces (7, Fig 1) of the telescope are lightly lubricated at the factory for optimum performance. Over a period of time, these surfaces may become dry or dirty. Simply clean off the bearing surfaces with a dry cloth or paper towel. Do not use solvents or alcohol-based cleaning solutions as this may damage the bearings or the painted surfaces of the telescope.
3. You will notice that your telescope will move in altitude by raising and lowering the tube, and in azimuth by rotating the base. As you observe objects in the night sky they will appear to drift out of the field of view due to the Earth's rotation. To keep an object centered in the field of view, just lightly nudge the telescope in the proper direction. This may take a little practice at first, but you'll soon get the hang of it.
4. Be sure the Mount is placed on a relatively level surface to allow proper operation. Each of the three feet should be in firm contact and not wobble. If you are in an area with particularly rough or soft ground, it may be helpful to place the Mount on a thick piece of plywood.
5. Part of the fun of using a Dobsonian type of telescope is the challenge of hunting for objects in the night sky. Invest in some simple star charts and books that tell you how to locate objects using a technique called "star hopping." Once you begin learning the star patterns and constellations, you're well on your way to finding many amazing sights.



Looking at or near the **Sun** will cause **irreversible** damage to your eye. Do not point this telescope at or near the Sun. Do not look through the telescope as it is moving.

CALCULATE MAGNIFICATION

The magnification, or power of a telescope is determined by two factors: the focal length of the eyepiece and the focal length of the telescope. Your telescope is supplied with one eyepiece. The focal length of the eyepiece, 26mm, is printed on its side.

Telescope focal length is the distance that light travels inside the telescope before reaching a focus.

The focal length of the Dobsonian 8" = 1219mm.

The focal length of the Dobsonian 10" = 1270mm

The focal length of the Dobsonian 12" = 1524mm

The focal length of the Dobsonian 16" = 1829mm

To change magnification, change eyepieces.

To calculate the magnification of a given eyepiece, use this formula:

$$\text{Power} = \text{Telescope Focal Length} \div \text{Eyepiece Focal Length}$$

Example: Using the 26mm eyepiece supplied with the 8" f/6, the power is:

$$\text{Power} = 1219\text{mm} \div 26\text{mm} = 47\text{mm}$$

The type of eyepiece, whether Modified Achromatic, Plössl, or Super Plössl, has no effect on magnification, but does have a bearing on such optical characteristics as field of view, flatness of field, and color correction.

Maximum practical magnification is about 50X per inch of aperture. Generally, however, lower powers produce higher image resolution. When unsteady air conditions prevail (as witnessed by rapid "twinkling" of the stars), extremely high powers result in distorted magnification and observational details are diminished by the use of excessive power.

When beginning observations on a particular object, always start with a low power eyepiece. Centered the object in the field of view. Sharply focus the object. Then try using a higher power eyepiece. If the image starts to become fuzzy when you use higher magnification, back down to a lower power. The atmosphere is not sufficiently steady to support high powers. Keep in mind that a bright, clearly resolved, but smaller image will show far more detail than a dimmer, poorly resolved larger image.

OBSERVING

Observe during the daytime: Try out your telescope during the daytime at first. It is easier to learn how it operates and how to observe when it is light.

Pick out an easy object to observe: A distant mountain, a large tree, a lighthouse or skyscraper make excellent targets. Point the optical tube so it lines up with your object.

Use the red dot finder: If you have not done so, align the red dot finder with the telescope's eyepiece as described earlier. Look through the finder until you can see the object. It will be easier to locate an object using the finder rather than locating with the eyepiece. Line up the object with the finder's red dot.

Look through the eyepiece: Once you have the object lined up in the finder, look through the optical tube's eyepiece. If you have aligned your finder, you will see the object in your eyepiece.

Focus: Look through the eyepiece and practice focusing on the object you have chosen. The focuser has both a lock knob and a tension adjustment knob. The first lock prevents the draw tube (16) from moving in and out. The second lock locks the focuser knob, thereby locking a focus position into place. Experiment with these knobs to discover which adjustments are comfortable with your viewing style.

Observe the Moon: When you feel comfortable with the finder, the eyepieces, the locks and the adjustment controls, you will be ready to try out the telescope at night. The Moon is the best object to observe the first time you go out at night. Pick a night when the Moon is a crescent. No shadows are seen during a full Moon, making it appear flat and uninteresting.



Looking at or near the **Sun** will cause **irreversible** damage to your eye. Do not point this telescope at or near the Sun. Do not look through the telescope as it is moving.



Craters of the Moon are excellent targets to observe.



The planet Jupiter. Jupiter's four largest moons can be observed in a different position every night.

Look for different features on the Moon: The most obvious features are craters. In fact you can see craters within craters. Some craters have bright lines about them. These are called rays and are the result of material thrown out of the crater when it was struck by a colliding object. The dark areas on the Moon are called maria and are composed of lava from the period when the Moon still had volcanic activity. You can also see mountain ranges and fault lines on the Moon.

Use a neutral density filter (sometimes called a "moon filter") when observing the Moon. Neutral density filters are available from Meade as an optional accessory.

Spend several nights observing the Moon. Some nights, the Moon is so bright that it makes other objects in the sky difficult to see. These are nights that are excellent for lunar observation.

Observe the Solar System: After observing the Moon, you are ready to step up to the next level of observation, the planets. There are four planets that you can easily observe in your telescope: Venus, Mars, Jupiter and Saturn.

Nine planets (maybe more...3 more planets have been discovered in the "Oort" cloud at print time) travel in a fairly circular pattern around our Sun. Any system of planets orbiting one or more stars is called a solar system. Our Sun, by the way, is a single, dwarf star. It is average as far as stars go and is a middle aged star.

Beyond the planets are clouds of comets, icy planetoids and other debris left over from the birth of our sun (the Oort cloud). Recently astronomers have found large objects in this area and they may increase the number of planets in our solar system.

The four planets closest to the Sun are rocky and are called the inner planets. Mercury, Venus, Earth and Mars comprise the inner planets. Venus and Mars can be easily seen in your telescope.

Venus is seen before dawn or after sunset, because it is close to the Sun. You can observe Venus going through crescent phases. But you cannot see any surface detail on Venus because it has a very thick atmosphere of gas.

When Mars is close to the Earth, you can see some details on Mars, and sometimes even Mars' polar caps. But quite often, Mars is further away and just appears as a red dot with some dark lines crisscrossing it.

Jupiter, Saturn, Uranus, Neptune and Pluto comprise the outer planets. These planets, except for Pluto, are made mostly of gases and are sometimes called gas giants. If they had grown much bigger, they may have become stars. Pluto is made mostly of ice.

Jupiter is quite interesting to observe. You can see bands across the face of Jupiter. The more time you spend observing these bands, the more details you will be able to see.

One of the most fascinating sights of Jupiter are its moons. The four largest moons are called the Galilean moons, after the astronomer Galileo, who observed them for the first time. If you've never watched the Galilean moons in your telescope before, you're missing a real treat! Each night, the moons appear in different positions around the Jovian sky. This is sometimes called the Galilean dance. On any given night, you might be able to see the shadow of a moon on the face of Jupiter, see one moon eclipse another or even see a moon emerge from behind Jupiter's giant disk. Drawing the positions of the moons each night is an excellent exercise for novice astronomers.

Any small telescope can see the four Galilean moons of Jupiter, plus a few others, but how many moons does Jupiter actually have? No one knows for sure! Nor are we sure how many Saturn has either. At last count, Jupiter had over 60 moons, and held a small lead over Saturn. Most of these moons are very small and can only be seen with very large telescopes.



Looking at or near the **Sun** will cause **irreversible** damage to your eye. Do not point this telescope at or near the Sun. Do not look through the telescope as it is moving.



M31, the Andromeda galaxy, is one of the easiest galaxies to locate and observe during the fall and winter evenings.



The Pleiades is probably the most striking star cluster to observe in the Northern Hemisphere.

Probably the most memorable sight you will see in your telescope is Saturn. Although you may not see many features on the surface of Saturn, its ring structure will steal your breath away. You will probably be able to see a black opening in the rings, known as the Cassini division.

Saturn is not the only planet that has rings, but it is the only set of rings that can be seen with a small telescope. Jupiter's rings cannot be seen from Earth at all—the Voyager spacecraft discovered the ring after it passed Jupiter and looked back at it. It turns out, only with the sunlight shining through them, can the rings be seen. Uranus and Neptune also have faint rings.

Optional color filters help bring out detail and contrast of the planets. Meade offers a line of inexpensive color filters.

What's Next? Beyond the Solar System: Once you have observed our own system of planets, it's time to really travel far from home and look at stars and other objects. You can observe thousands of stars with your telescope. At first, you may think stars are just pinpoints of light and aren't very interesting. But look again. There is much information that is revealed in stars.

The first thing you will notice is that not all stars are the same colors. See if you can find blue, orange, yellow, white and red stars. The color of stars sometimes can tell you about the age of a star and the temperature that they burn at.

Other stars to look for are multiple stars. Very often, you can find double (or binary) stars, stars that are very close together. These stars orbit each other. What do you notice about these stars? Are they different colors? Does one seem brighter than the other?

Almost all the stars you can see in the sky are part of our galaxy. A galaxy is a large grouping of stars, containing millions or even billions of stars. Some galaxies form a spiral (like our galaxy, the Milky Way) and other galaxies look more like a large football and are called elliptical galaxies. There are many galaxies that are irregularly shaped and are thought to have been pulled apart because they passed too close to—or even through—a larger galaxy.

You may be able to see the Andromeda galaxy and several others in your telescope. They will appear as small, fuzzy clouds.

You will also be able to see some nebulas with your scope. Nebula means cloud. Most nebulas are clouds of gas. The two easiest to see in the Northern Hemisphere are the Orion nebula during the winter and the Trifid nebula during the summer. These are large clouds of gas in which new stars are being born. Some nebulas are the remains of stars exploding. These explosions are called supernovas.

When you become an advanced observer you can look for other types of objects such as asteroids, planetary nebula and globular clusters. And if you're lucky, every so often a bright comet appears in the sky, presenting an unforgettable sight.

The more you learn about objects in the sky, the more you will learn to appreciate the sights you see in your telescope. Start a notebook and write down the observations you make each night. Note the time and the date.

Use a compass to make a circle, or trace around the lid of a jar. Draw what you see in your eyepiece inside the circle. The best exercise for drawing is to observe the moons of Jupiter every night or so. Try to make Jupiter and the moons approximately the same size as they look in your eyepiece. You will see that the moons are in a different position every night. As you get better at drawing, try more challenging sights, like a crater system on the moon or even a nebula.

Go your library or check out the internet for more information about astronomy. Learn about the basics: Light years, orbits, star colors, how stars and planets are formed, red shift, the big bang, what are the different kinds of nebula, what are comets, asteroids and meteors and what is a black hole. The more you learn about astronomy, the more fun, and the more rewarding your telescope will become.



Looking at or near the **Sun** will cause **irreversible** damage to your eye. Do not point this telescope at or near the Sun. Do not look through the telescope as it is moving.



Venus, in its thin, crescent phase.

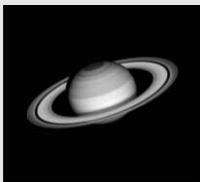

Saturn is the perhaps the most unforgettable sight to see in a telescope.

SOME TIPS

By the way, you might have noticed something strange when you looked through your eyepiece. The image is upside down, and it is also reversed. That means reading words can be a problem or viewing objects on the ground can be a problem. But it has no affect on astronomical objects.

Objects move in the eyepiece: If you are observing an astronomical object (the Moon, a planet, star, etc.) you will notice that the object will begin to move slowly through the telescopic field of view. This movement is caused by the rotation of the Earth and makes an object move through the telescope's field of view. To keep astronomical objects centered in the field, simply move the telescope on one or both of its axes—vertically and/or horizontally as needed. At higher powers, astronomical objects will seem to move through the field of view of the eyepiece more rapidly.

Place the object to be viewed at the edge of the field and, without touching the telescope, watch it drift through the field to the other side before repositioning the telescope so that the object to be viewed is again placed at the edge of the field, ready to be further observed.

Vibrations: Avoid touching the eyepiece while observing through the telescope. Vibrations resulting from such contact will cause the image to move. Avoid observing sites where vibrations cause image movement (for example, near railroad tracks). Viewing from the upper floors of a building may also cause image movement.

Let your eyes “dark-adapt:” Allow five or ten minutes for your eyes to become “dark adapted” before observing. Use a red-filtered flashlight to protect your night vision when reading star maps, or inspecting the telescope. Do not use use a regular flashlight or turn on other lights when observing with a group of other astronomers. You can make your own red filtered flashlight by taping red cellophane over a flashlight lens.

Viewing through windows: Avoid setting up the telescope inside a room and observing through an opened or closed window pane. Images may appear blurred or distorted due to temperature differences between inside and outside air. Also, it is a good idea to allow your telescope to reach the ambient (surrounding) outside temperature before starting an observing session.

When to observe: Planets and other objects viewed low on the horizon often lack sharpness—the same object, when observed higher in the sky, will appear sharper and have greater contrast. Try reducing power (change your eyepiece) if your image is fuzzy or shimmers. Keep in mind that a bright, clear, but smaller image is more interesting than a larger, dimmer, fuzzy one. Using too high a power eyepiece is one of the most common mistakes made by new astronomers.

Dress Warm: Even on summer nights, the air can feel cool or cold as the night wears on. It is important to dress warm or to have a sweater, jacket, gloves, etc., nearby.

Know your observing site: If possible, know the location where you will be observing. Pay attention to holes in the ground and other obstacles. Is it a location where wild animals, such as skunks, snakes, etc., may appear? Are there viewing obstructions such as tall trees, street lights, headlights and so forth? The best locations are dark locations, the darker the better. Deep space objects are easiest to see under dark skies. But it is still possible to observe even in a city.

Surf the Web and visit your local library: The internet contains a huge amount of astronomical information, both for children and adults. Check out astronomy books from your library. Look for star charts—these are available on a monthly basis in *Astronomy* and *Sky and Telescope* magazines.

CARE OF OPTICS

Your Meade telescope is a fine instrument. With reasonable care, it will last a lifetime. Maintenance guidelines include:

- a. Avoid cleaning the telescope's optics: A little dust on the front surface of the telescope's correcting lens causes virtually no degradation of image quality and should not be considered reason to clean the lens.



Looking at or near the **Sun** will cause **irreversible** damage to your eye. Do not point this telescope at or near the Sun. Do not look through the telescope as it is moving.

- b. When absolutely necessary, dust on the mirror should be blown off with an ear syringe (available at any pharmacy). **DO NOT** use a commercial photographic lens cleaner.
- c. Organic materials (e.g., fingerprints) on the front lens may be removed with a solution of 3 parts distilled water to 1 part isopropyl alcohol. You may also add 1 drop of biodegradable dishwashing soap per pint of solution. Use soft, white facial tissues and make short, gentle strokes. Change tissues often.

Caution: Do not use scented or lotioned tissues or damage could result to the optics.

- d. If the telescope is used outdoors on a humid night, water condensation on the telescope surfaces will probably result. While such condensation does not normally cause any damage to the telescope, it is recommended that the entire telescope be wiped down with a dry cloth before the telescope is packed away. Do not, however, wipe any of the optical surfaces. Rather, simply allow the telescope to sit for some time in the warm indoor air, so that the wet optical surfaces can dry unattended.
- e. If your telescope is not to be used for an extended period, perhaps for one month or more, it is advisable to remove the batteries from the battery pack. Batteries left in the telescope for prolonged periods may leak, causing damage.
- g. Do not leave your telescope inside a sealed car on a warm summer day; excessive ambient temperatures can damage the telescope's internal lubrication

MEADE CUSTOMER SERVICE

If you have a question concerning your LightBridge Truss Tube Dobsonian, contact the Meade Instruments Customer Service Department at (800) 626-3233. Customer Service hours are 8:00 AM to 5:00 PM, Pacific Time, Monday through Friday. In the unlikely event that your LightBridge Dobsonian requires factory servicing or repairs, write or call the Meade Customer Service Department first, before returning the telescope to the factory, giving full particulars as to the nature of the problem, as well as your name, address, and daytime telephone number. The great majority of servicing issues can be resolved by telephone, avoiding return of the telescope to the factory. If factory service is required, you will be assigned a Return Goods Authorization (RGA) number prior to return.



SPECIFICATIONS

8" Deluxe Model

OTA

Open truss design. Upper cage metal tube containing spider and secondary mirror holder, focuser with attachment points for truss tubes. Lower metal tube containing mirror cell, altitude bearings, battery powered fan, with truss tube attachment castings and captive bolts and knobs. Silver anodized aluminum with attachment hardware and captive bolts. Machined aluminum altitude bearings.

Truss tubes

4-vane, steel
8"

Secondary Mirror Support
Mirror

Focal length 1219mm (48")

Focal ratio f/6

Resolving Power 0.74 arc seconds

Limiting visual magnitude 13.5

Focuser 2" Crayford style machined aluminum with 1.25" adapter.

Mount Swivel base with Teflon bearings for azimuth.

Base bearings Three roller bearing plates

Eyepiece tray For one 2" and three 1.25" eyepieces mounted on one side of the base.

Eyepiece Meade 26mm QX Wide Angle Eyepiece.

Dust Cover To fit over primary mirror inside of lower tube.

Finder Deluxe red dot

Computer Software CD-ROM of Autostar Suite Astronomer's Edition software

Assembled OTA weight 24 lbs.

Assembled Mount weight 20 lbs.

Total Assembled telescope wt. 44 lbs.

10" Standard Model

OTA

Open truss design. Upper cage metal tube containing spider and secondary mirror holder, focuser with attachment points for truss tubes. Lower metal tube containing mirror cell, altitude bearings, battery powered fan, with truss tube attachment castings and captive bolts and knobs. Silver anodized aluminum with attachment hardware and captive bolts. Machined aluminum altitude bearings.

Truss tubes

4-vane, steel
10"

Secondary Mirror Support
Mirror

Focal length 1270mm (50")

Focal ratio f/5

Resolving Power 0.56 arc seconds

Limiting visual magnitude 14

Focuser 2" Crayford style machined aluminum with 1.25" adapter.

Mount Swivel base with Teflon bearings for azimuth.

Base bearings Three roller bearing plates

Eyepiece tray For one 2" and three 1.25" eyepieces mounted on one side of the base.

Eyepiece Meade 26mm QX Wide Angle Eyepiece.

Dust Cover To fit over primary mirror inside of lower tube.

Finder Deluxe red dot

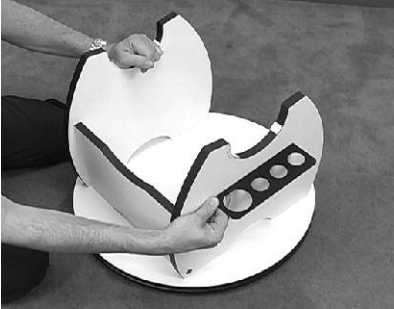

Attach eyepiece tray to side or back base panels.



Looking at or near the **Sun** will cause **irreversible** damage to your eye. Do not point this telescope at or near the Sun. Do not look through the telescope as it is moving.

Computer Software	CD-ROM of Autostar Suite Astronomer's Edition software
Assembled OTA weight	38 lbs.
Assembled Mount weight	27 lbs.
Total Assembled telescope wt.	65 lbs.

12" Standard Model

OTA	Open truss design. Upper cage metal tube containing spider and secondary mirror holder, focuser with attachment points for truss tubes. Lower metal tube containing mirror cell, altitude bearings, battery powered fan, with truss tube attachment castings and captive bolts and knobs. All 12 inch models have a triangular ground plate.
Truss tubes	Silver anodized aluminum with attachment hardware and captive bolts. Machined aluminum altitude bearings.
Secondary Mirror Support Mirror	4-vane, steel 12"
Focal length	1524mm (60")
Focal ratio	f/5
Resolving Power	0.45 arc seconds
Limiting visual magnitude	14.5
Focuser	2" Crayford style machined aluminum with 1.25" adapter.
Mount	Swivel base with Teflon bearings for azimuth.
Base bearings	Three roller bearing plates
Eyepiece tray	For one 2" and three 1.25" eyepieces mounted on one side of the base.
Counterweight	None
Eyepiece	Meade 26mm QX Wide Angle Eyepiece.
Dust Cover	To fit over primary mirror inside of lower tube.
Finder	Deluxe red dot
Computer Software	CD-ROM of Autostar Suite Astronomer's Edition software
Assembled OTA weight	47 lbs.
Assembled Mount weight	33 lbs.
Total Assembled telescope wt.	80 lbs.



16" Deluxe Model

OTA

Open truss design. Upper cage metal tube containing spider and secondary mirror holder, focuser with attachment points for truss tubes. Lower metal tube containing mirror cell, altitude bearings, battery powered fan, with truss tube attachment castings and captive bolts and knobs.

Truss tubes

All 16 inch models have a triangular ground plate. Silver anodized aluminum with attachment hardware and captive bolts. Machined aluminum altitude bearings.

Secondary Mirror Support Mirror

4-vane, steel
16" (406mm)

Focal length

1829mm (72")

Focal ratio

f/4.5

Resolving Power

0.45 arc seconds

Limiting visual magnitude

14.5

Focuser

10 to 1 dual-speed 2" Crayford style machined aluminum with 1.25" adapter.

Mount

Swivel base with Teflon bearings for azimuth.

Eyepiece tray

For one 2" and three 1.25" eyepieces mounted on one side of the base.

Counterweight

None

Eyepiece

Meade 26mm Super Plössl

Dust Cover

To fit over primary mirror inside of lower tube.

Finder

Standard red dot

Computer Software

CD-ROM of Autostar Suite Astronomer's Edition software

Assembled OTA weight

74 lbs.

Assembled Mount weight

54 lbs.

Total Assembled telescope wt. 128 lbs.



Looking at or near the **Sun** will cause **irreversible** damage to your eye. Do not point this telescope at or near the Sun. Do not look through the telescope as it is moving.

OPTIONAL ACCESSORIES

A wide assortment of professional Meade accessories is available for the LightBridge telescope models. The premium quality of these accessories is well-suited to the quality of the instrument itself. **Consult the Meade General Catalog or meade.com for complete details on these and other accessories.**

Meade Series 4000™ Eyepieces: You want to select an eyepiece that not only gives you the magnification that you want, but also give you the eye relief you need. Other qualities to look for with eyepieces are the apparent field size, which is how large an object looks in an eyepiece, and coatings, which increase contrast in an image. Meade's series series 5000 eyepieces incorporate all the features that you'd want in a set of high quality eyepieces. It is recommended that observers have two or three low and high power eyepiece on hand such as a 9mm ,12mm, and 40mm, in addition to the supplied 26mm. And remove the 1.25 eyepiece holder and your LightBridge is ready to use 2" diameter eyepieces.

Series 5000™ TeleXtenders: An advanced 4-element design doubles, triples or quadruples magnification while flattening the field of view, and the fully coated lenses deliver the maximum light transmission, the highest contrast and an image free of color fringing. Maintains a comfortable eye relief of longer focal length eyepieces, while increasing magnification.

Series 4000™ 8 - 24mm Zoom Eyepiece: The internal zoom optics of this eyepiece move on smooth, precisely machined surfaces which maintain optical collimation at all zoom settings. A scale graduated in 1mm units indicates the zoom focal length in operation. An excellent addition to any eyepiece set.

Series 4000™ Photo-Visual Color Filters: Color filters significantly enhance visual and photographic image contrast of the Moon and planets. Each filter threads into the barrel of any Meade 1.25" eyepiece, and into the barrels of virtually all other eyepiece brands as well. Meade filters are available in 12 colors for lunar and planetary applications, and in Neutral Density as a lunar glare-reduction filter.

Series 4000™ Nebular Filters: A modern boon to the city-dwelling deep-space observer, the interference nebular filter effectively cancels out the effects of most urban light pollution, while leaving the light of deep-space nebular emissions virtually unattenuated. Meade **Series 4000 Nebular Filters** utilize the very latest in coating technology.

Meade Laser Collimator: The Meade Laser Collimator is an easy to use collimation device. Poor collimation can cause planetary detail to be fuzzy and star images to appear elongated or irregular. The Laser Collimator uses a red laser to accurately align the mirrors in your LightBridge Truss Tube Dobsonian telescope. Once accurately aligned, stars will appear as sharp pinpoints, planets will reveal spectacular detail, and double stars can be easily split. Simply insert the laser collimator into the eyepiece holder of the telescope, and make small adjustments to the secondary and primary mirror to center the red dot of the laser. Once centered your Telescope is in collimation and ready to use.

Shroud: The shroud seals off the LightBridge telescope from all stray light. Attaches easily with velcro strips.

More accessories will soon be available for your LightBridge Truss Tube Dobsonian telescope. To find out more about these and other accessories available for your telescope, check out the Meade General Catalog, meade.com or contact your local Meade dealer. Also check out Meade's latest ads in Sky and Telescope and Astronomy magazine.



Fig. 12: Series 5000 5 Element Plossl Eyepieces.



Fig. 13: Series 5000 Super Wide Angle Eyepieces.



Fig. 14: Series 5000 Ultra Wide Angle Eyepieces.



Fig. 15: Series 5000 TELEXTENDERS.



Looking at or near the **Sun** will cause **irreversible** damage to your eye. Do not point this telescope at or near the Sun. Do not look through the telescope as it is moving.

Appendix A: Altitude Adjustment Knob

The Altitude Adjustment Knob allows you to add larger eyepieces, cameras or other accessories to the Meade LightBridge telescope without causing the tube to slip or drift.

Assembly

Slide the brake over the tension adjustment bolt (Fig. 16). Note the protrusion at the bottom of the tension plate. The protrusion fits into the indent at the bottom of the brake.

Thread the tension adjustment bolt into the tension plate on the side panel of the base assembly (Fig. 17).

Tighten or loosen this knob as needed to prevent the telescope from slipping or drifting when larger eyepieces or other accessories are used with the telescope (Fig. 18).

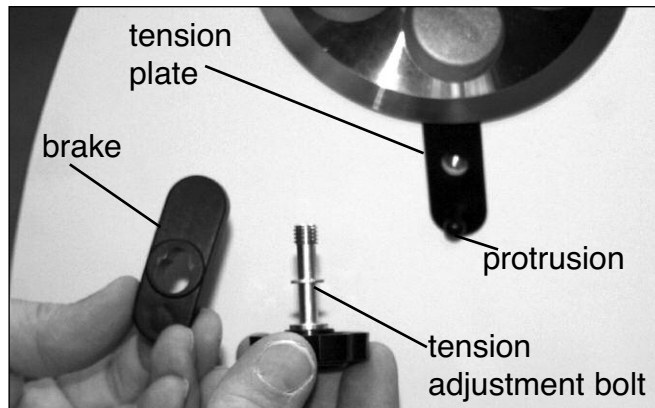

Fig. 16: The altitude tension adjustment assembly.



Fig. 17: Slide the brake over tension adjustment bolt and thread the tension adjustment bolt into the tension plate.



Fig. 18: Tighten the tension adjustment bolt as necessary.



Looking at or near the **Sun** will cause **irreversible** damage to your eye. Do not point this telescope at or near the Sun. Do not look through the telescope as it is moving.

MEADE LIMITED WARRANTY

Every Meade telescope and telescope accessory is warranted by Meade Instruments Corporation (“Meade”) to be free of defects in materials and workmanship for a period of ONE YEAR from the date of original purchase in the U.S.A. and Canada. Meade will repair or replace a product, or part thereof, found by Meade to be defective, provided the defective part is returned to Meade, freight-prepaid, with proof of purchase. This warranty applies to the original purchaser only and is non-transferable. Meade products purchased outside North America are not included in this warranty, but are covered under separate warranties issued by Meade international distributors.

RGA Number Required: Prior to the return of any product or part, a Return Goods Authorization (RGA) number **must** be obtained from Meade by writing, or calling (800) 626-3233. Each returned part or product must include a written statement detailing the nature of the claimed defect, as well as the owner’s name, address, and phone number.

This warranty is not valid in cases where the product has been abused or mishandled, where unauthorized repairs have been attempted or performed, or where depreciation of the product is due to normal wear-and-tear. Meade specifically disclaims special, indirect, or consequential damages or lost profit which may result from a breach of this warranty. Any implied warranties which cannot be disclaimed are hereby limited to a term of one year from the date of original retail purchase.

This warranty gives you specific rights. You may have other rights which vary from state to state.

Meade reserves the right to change product specifications or to discontinue products without notice.



MEADE®

6001 Oak Canyon, Irvine, California 92618
(800) 626-3233 ■ www.meade.com